

AURA DOME™ ARCHITECTURE





目次

Aura Dome All Models	4
----------------------------	---

Aura Bubble

直径3m 高さ2.4m	5
直径3.5m 高さ2.8m	6

Aura Dome

直径3.6m 高さ2.14m	7
直径4m 高さ2.38m	8
直径4.5m 高さ2.6m	9
直径5m 高さ3m	10
直径6m 高さ3m	11
直径7m 高さ3.5m	12
直径7m 高さ4.15m	13
直径8m 高さ3.86m	14
直径9m 高さ4.5m	15
直径10m 高さ5m	16
直径11m 高さ5.5m	17
直径12m 高さ6m	18

½ Aura Shelter

直径4.5m 高さ2.67m	19
直径5m 高さ2.5m	20
直径6m 高さ3m	21
直径7m 高さ3.5m	22
直径8m 高さ4m	23
直径9m 高さ4.5m	24
直径10m 高さ5m	25

⅔ Aura Shelter

直径5m 高さ2.5m	26
直径6m 高さ3m	27
直径7m 高さ3.5m	28
直径8m 高さ4m	29
直径9m 高さ4.5m	30
直径10m 高さ5m	31

Aura Glamping

直径6m 高さ3m	32
直径7m 高さ3.5m	33
直径8m 高さ4m	34
直径9m 高さ4.5m	35
直径10m 高さ5m	36

Aura Tunnel

長さ24m 幅12m	37
長さ4.87m 幅2.44m	38
長さ13m 幅5m	39

お問合せ	40
------------	----

Aura Dome All Models

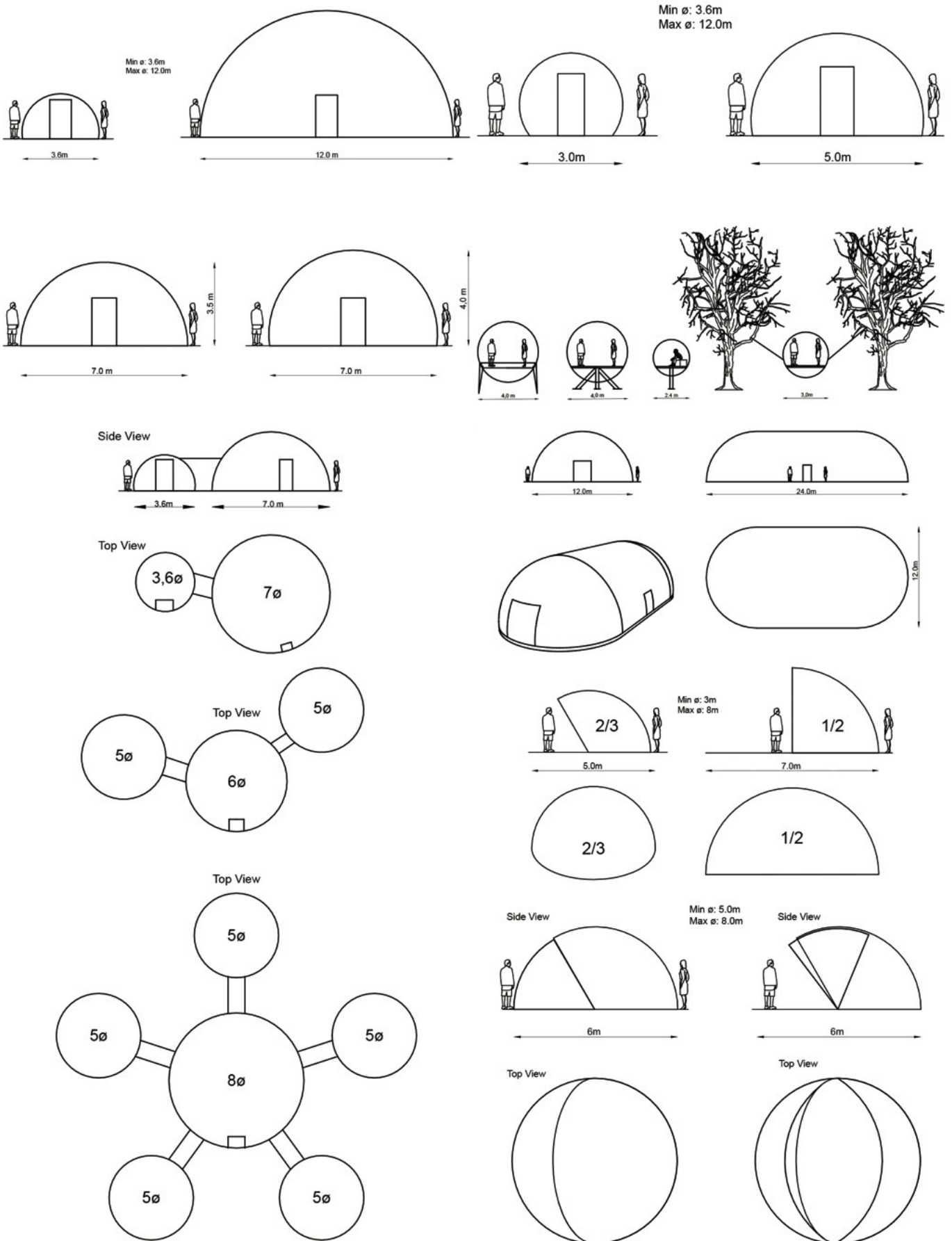

Aura Bubble 直径3m 高さ2.4m

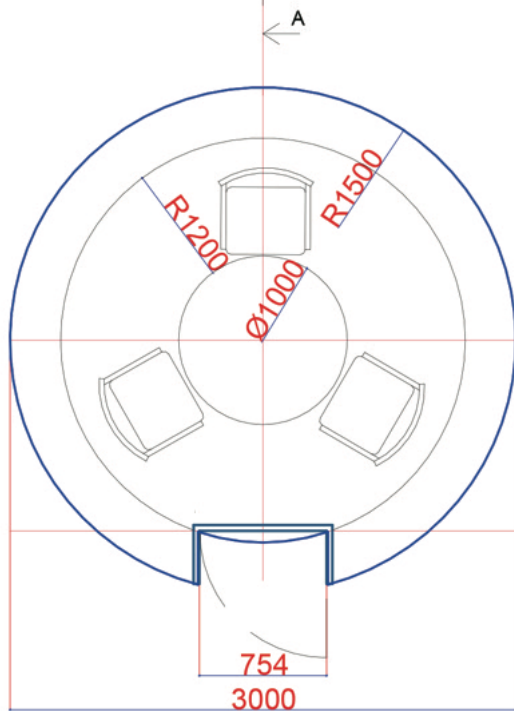
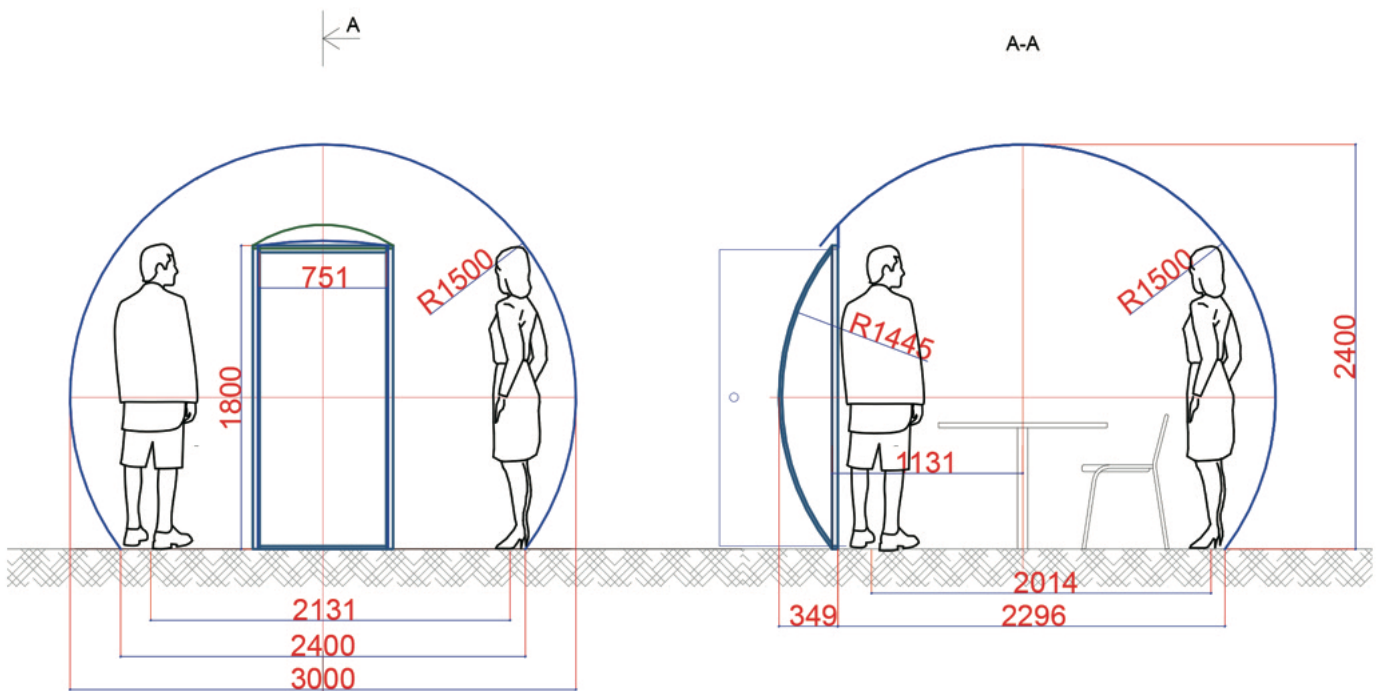

Structure



- 球面面積 ——— 22m²
- 床面積 ——— 4.5m²
- 内容積 ——— 12m³
- 重量 ——— 100kg

Aura Bubble 直径3.5m 高さ2.8m

SECTION A-A

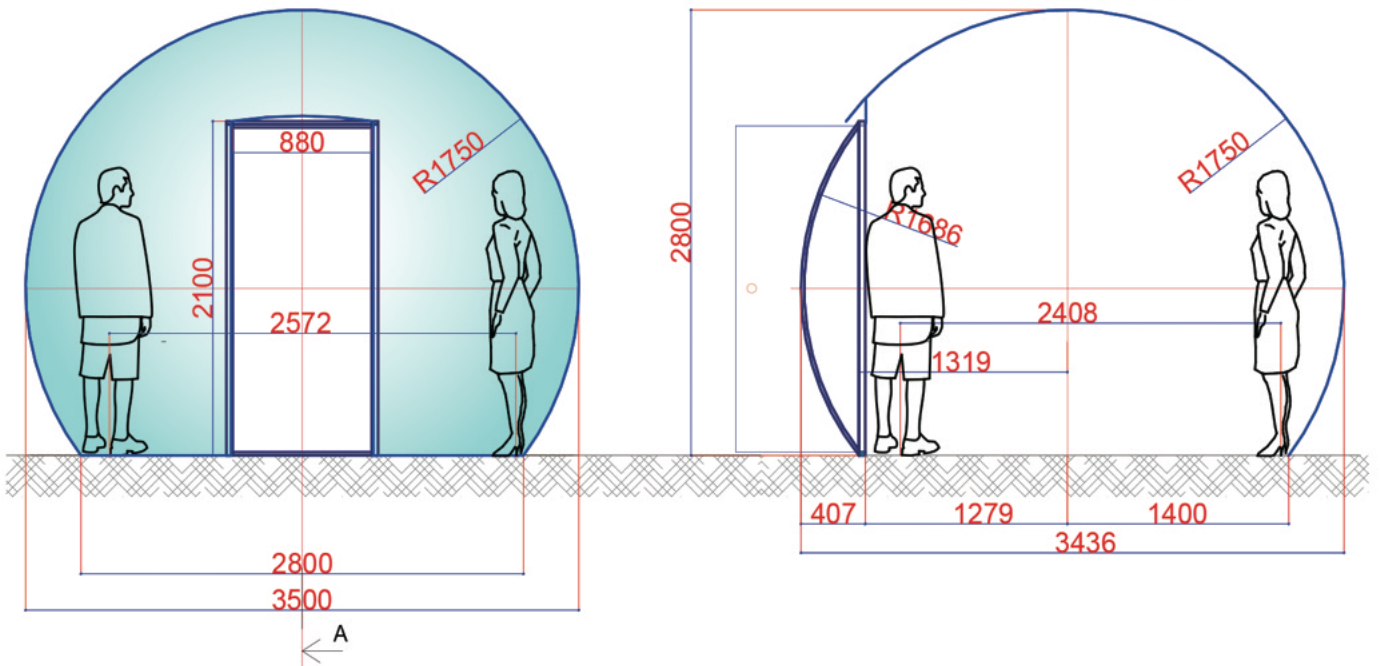

Structure

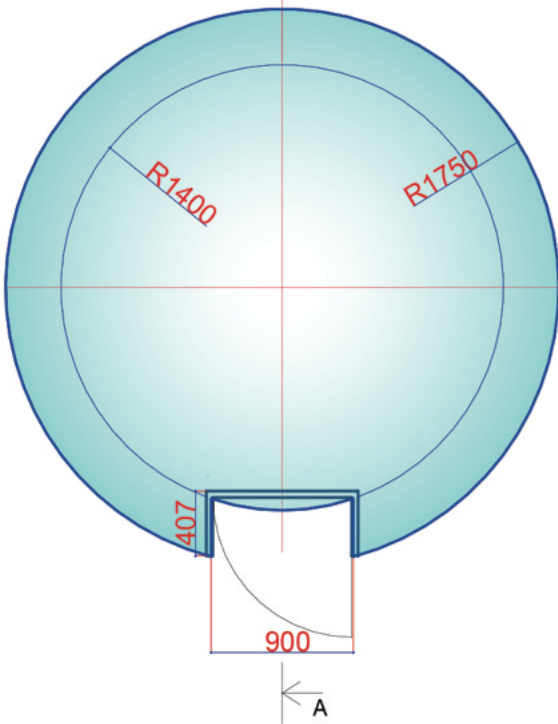

球面面積 ——— 30.8㎡

床面積 ——— 5.8㎡

内容積 ——— 20㎡

重量 ——— 235kg

Aura Dome 直径3.6m 高さ2.14m

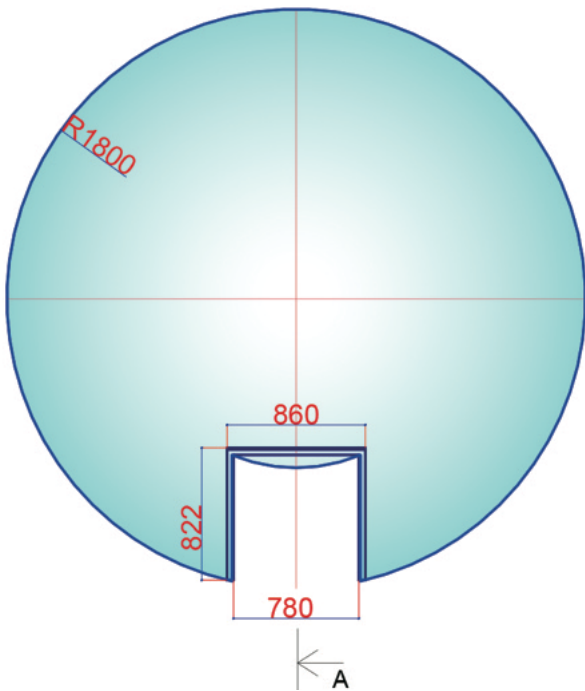
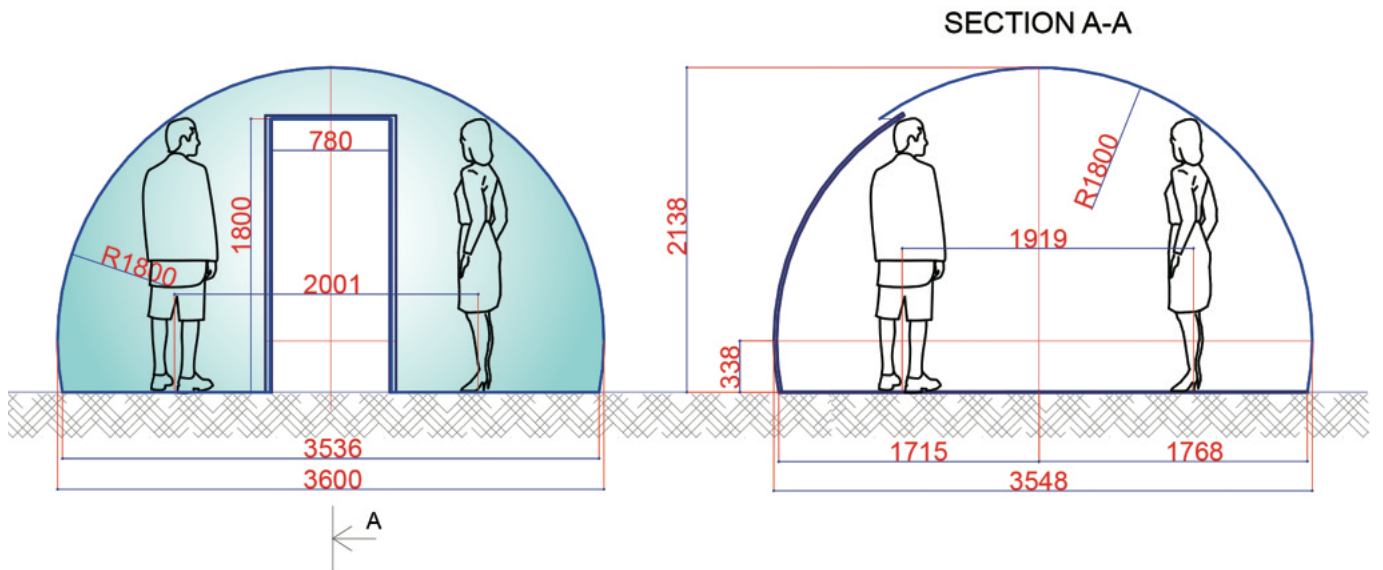

Structure



- 球面面積 —— 24m²
- 床面積 —— 9.8m²
- 内容積 —— 16m³
- 重量 —— 120kg

Aura Dome 直径4m 高さ2.38m

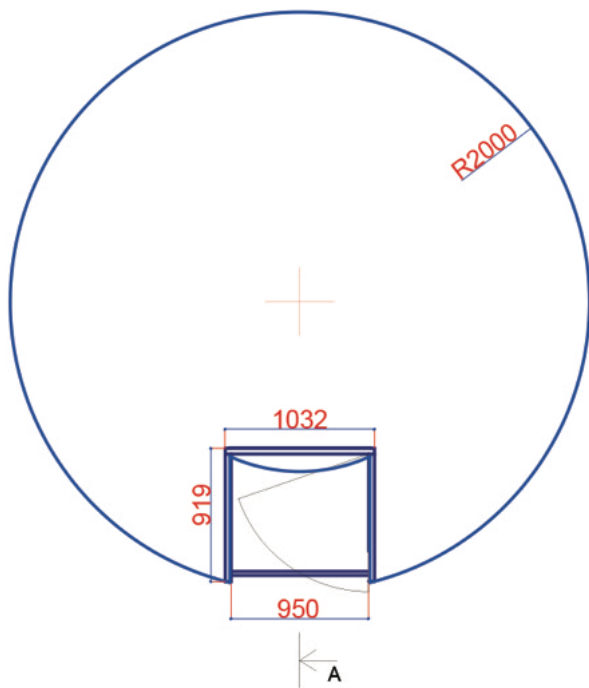
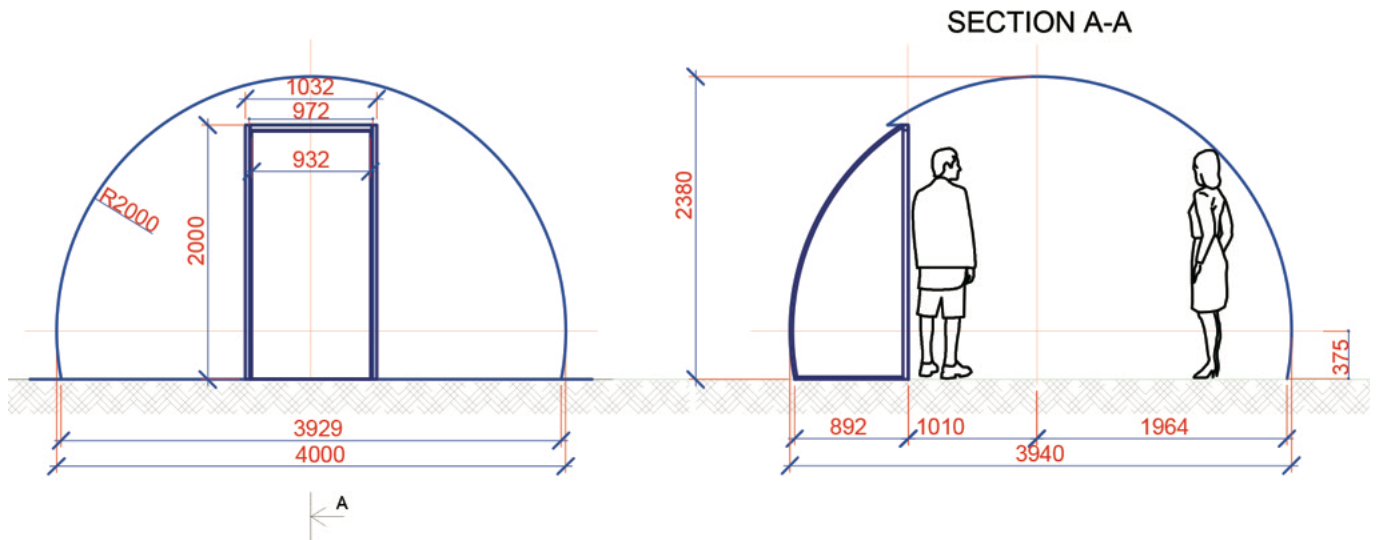

Structure



球面面積	——	30㎡
床面積	——	12㎡
内容積	——	20㎡
重量	——	170kg

Aura Dome 直径4.5m 高さ2.6m

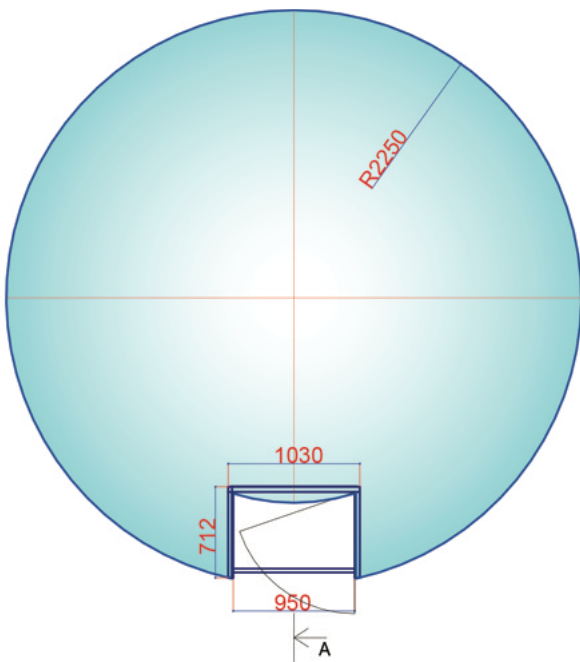
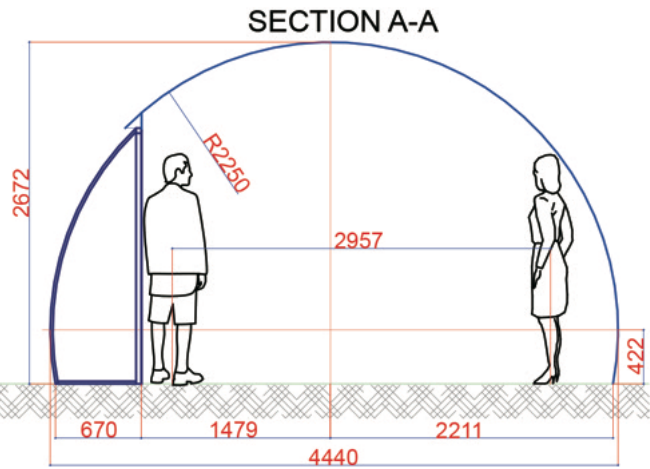
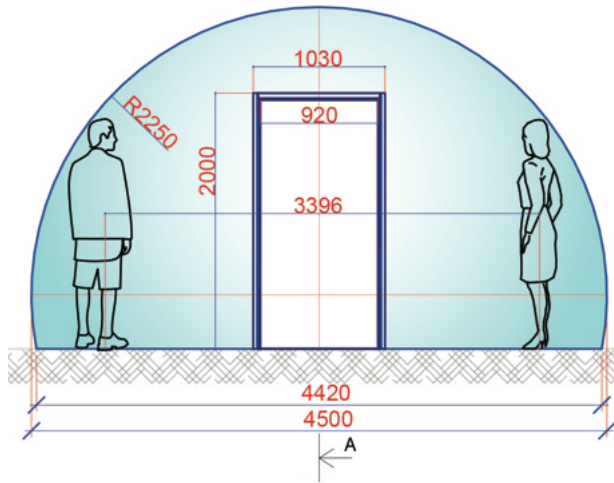

Structure



球面面積	——	38㎡
床面積	——	15㎡
内容積	——	30㎡
重量	——	265kg

Aura Dome 直径5m 高さ3m

SECTION A-A

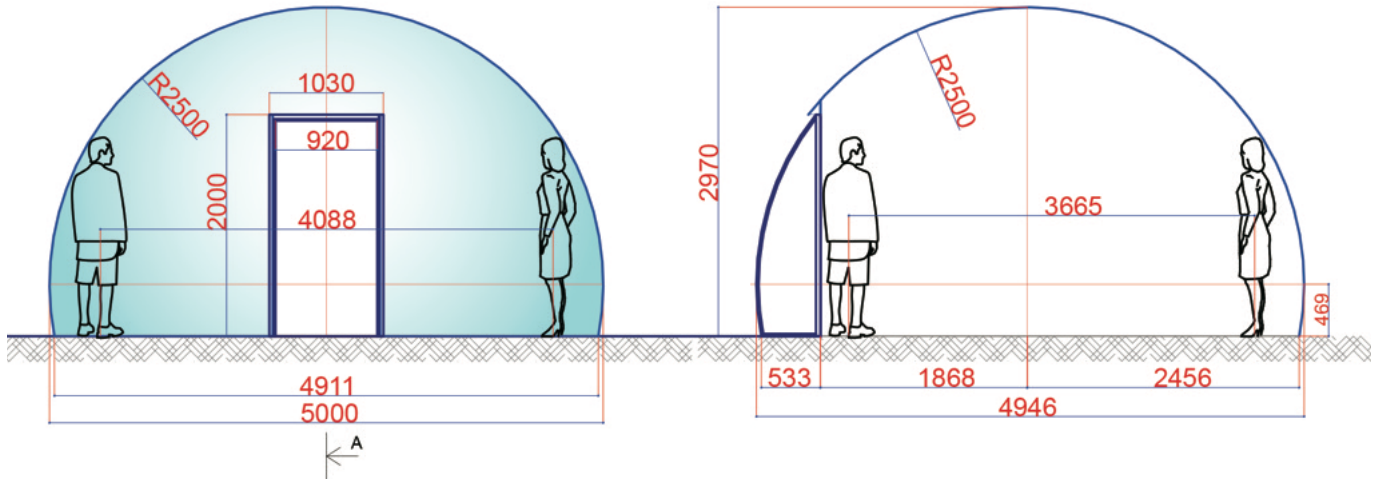

Structure

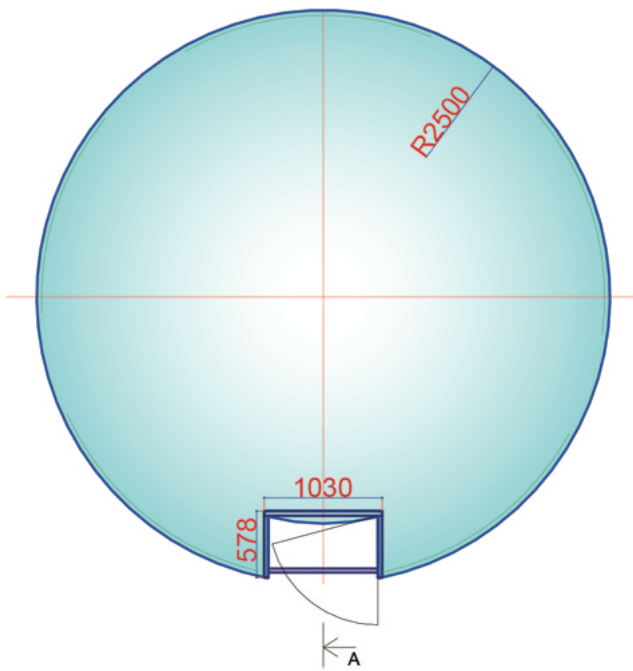

- 球面面積 —— 47m²
- 床面積 —— 19m²
- 内容積 —— 42m³
- 重量 —— 275kg

Aura Dome 直径6m 高さ3m

SECTION A-A

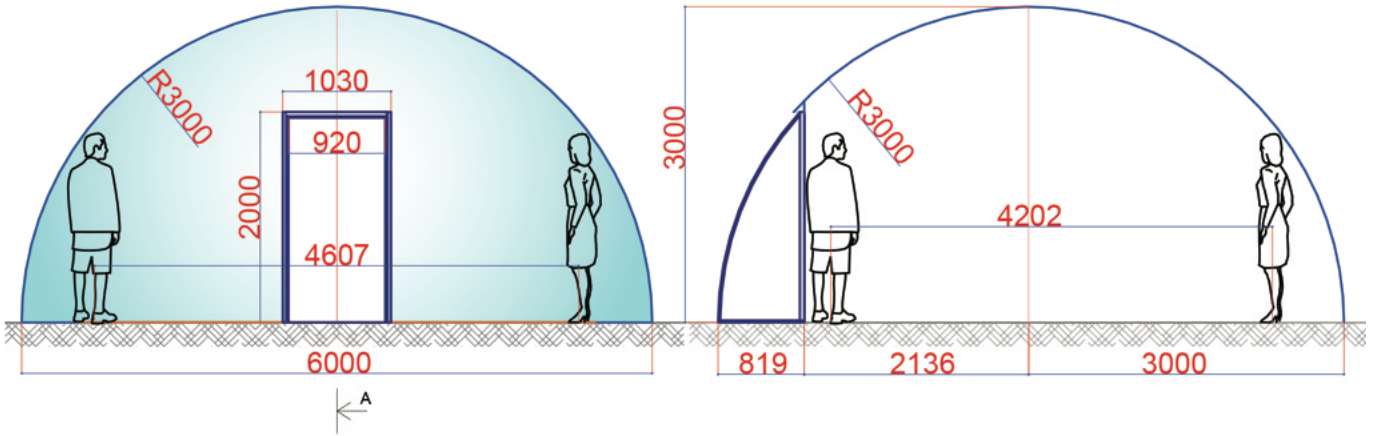

Structure

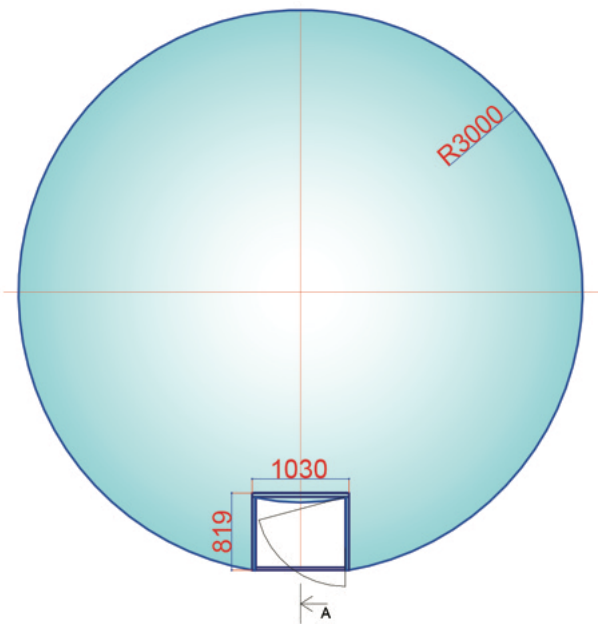

- 球面面積 —— 56m²
- 床面積 —— 28m²
- 内容積 —— 56m³
- 重量 —— 342kg

Aura Dome 直径7m 高さ3.5m

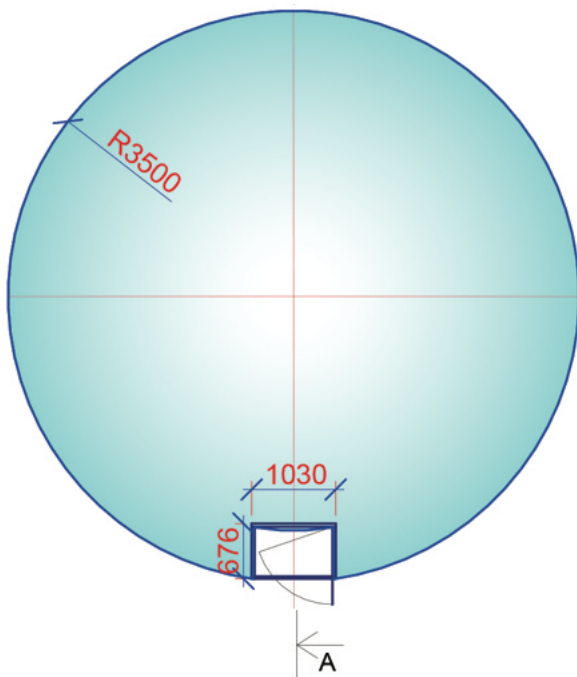
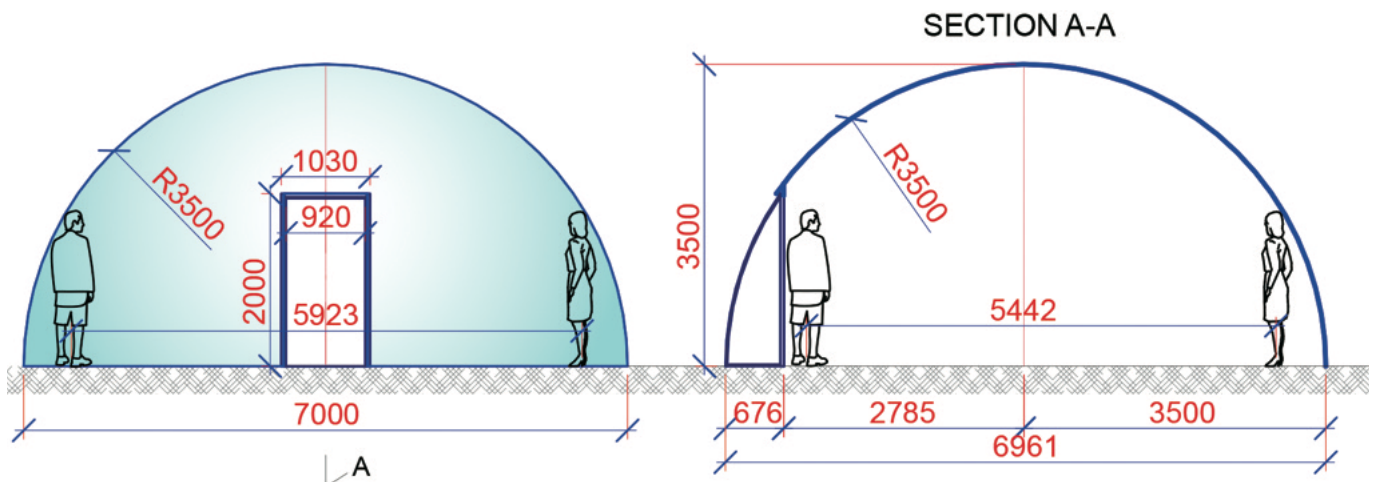

Structure



球面面積	——	78m ²
床面積	——	38.5m ²
内容積	——	90m ³
重量	——	437kg

Aura Dome 直径7m 高さ4.15m

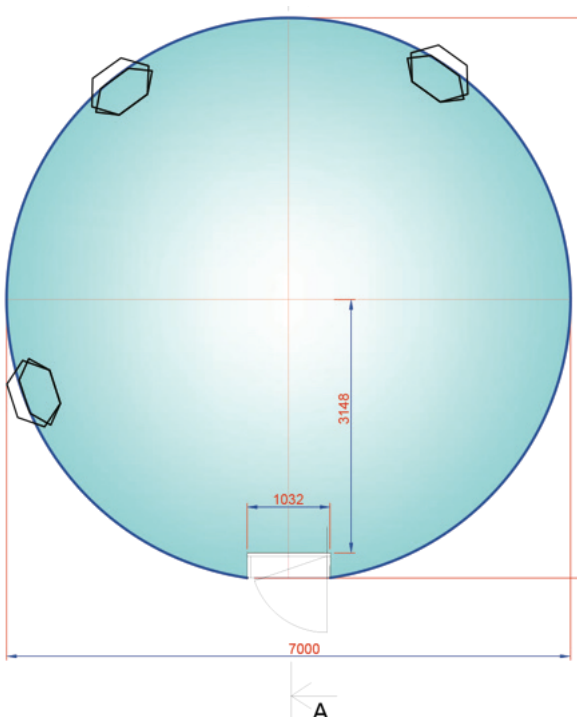
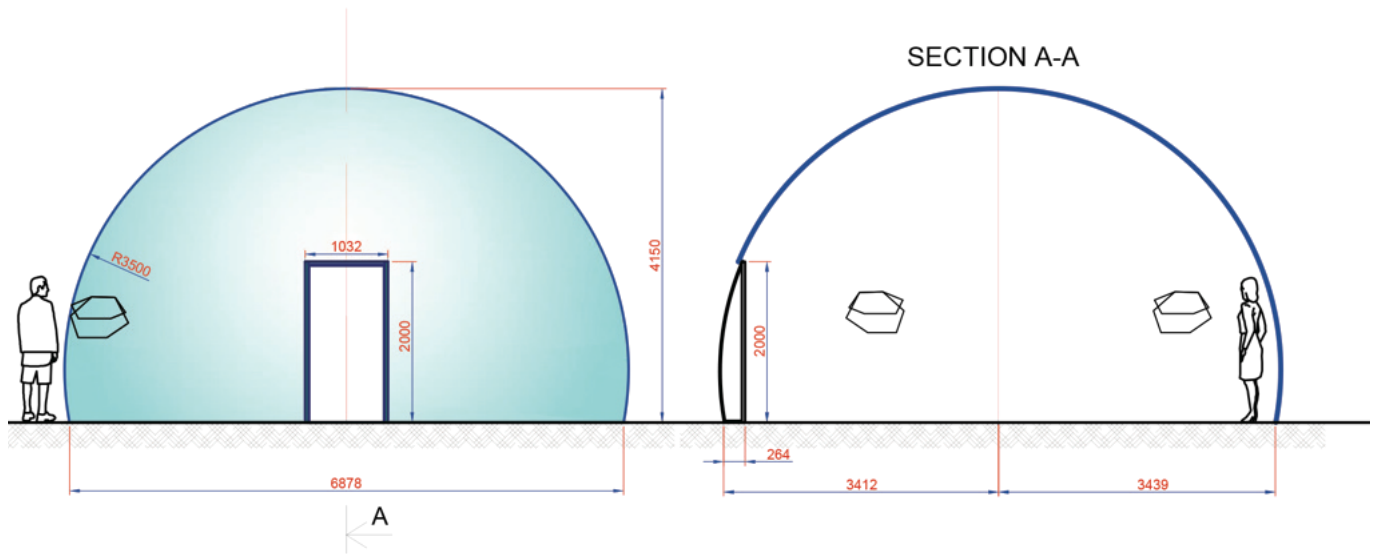

Structure



- 球面面積 —— 91m²
- 床面積 —— 37m²
- 内容積 —— 114m³
- 重量 —— 624kg

Aura Dome 直径8m 高さ3.86m

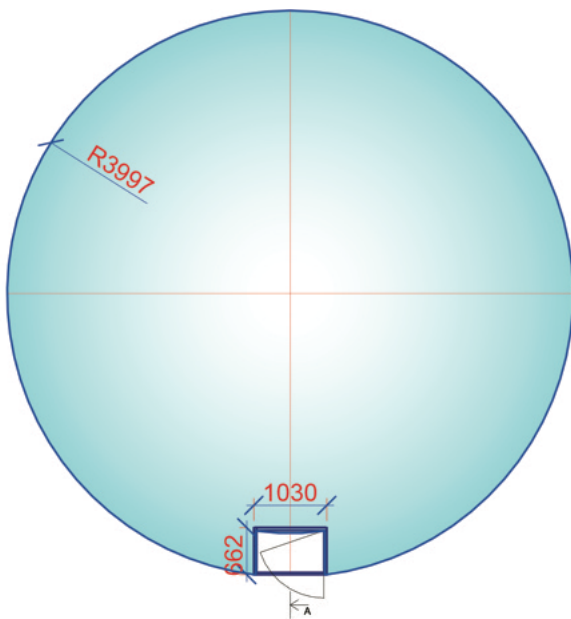
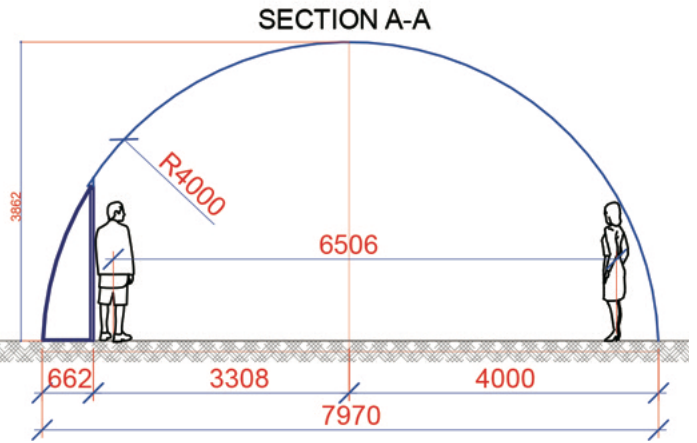
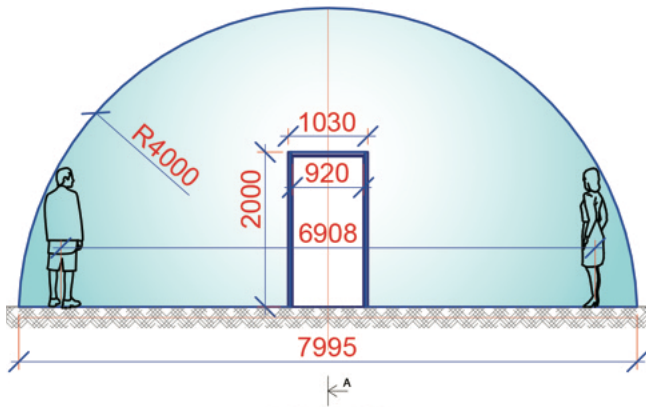

Structure



球面面積	——	97m ²
床面積	——	50m ²
内容積	——	127m ³
重量	——	660kg

Aura Dome 直径9m 高さ4.5m

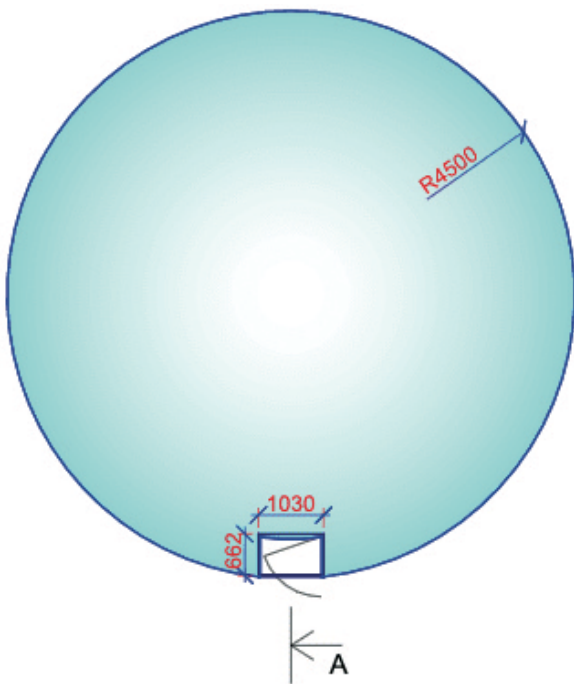
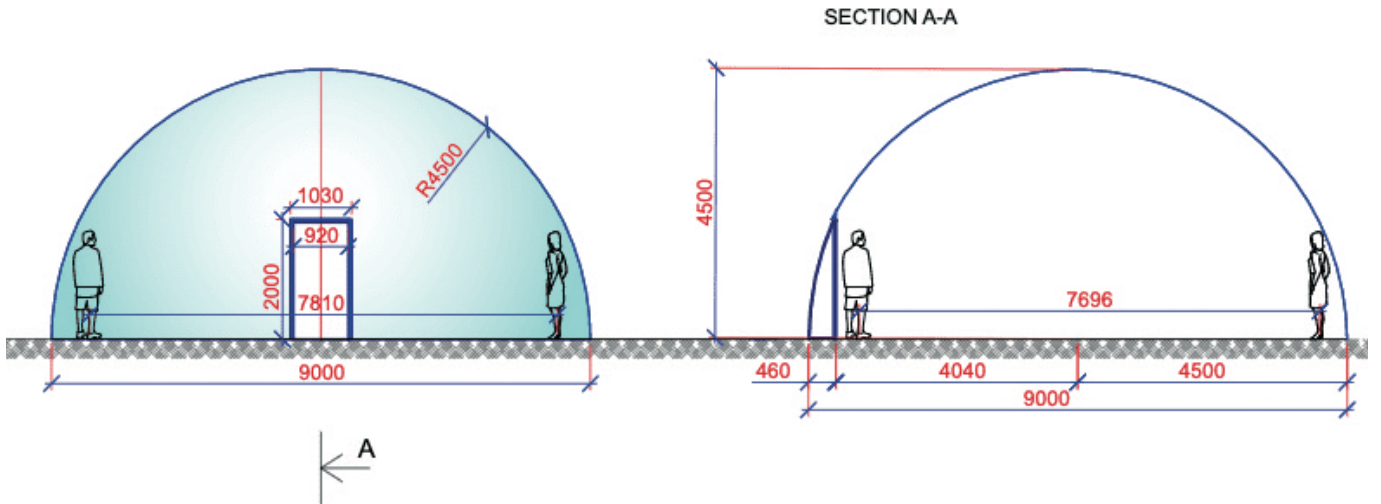

Structure



- 球面面積 —— 127.2㎡
- 床面積 —— 63.6㎡
- 内容積 —— 190.74㎡
- 重量 —— 721kg

Aura Dome 直径10m 高さ5m

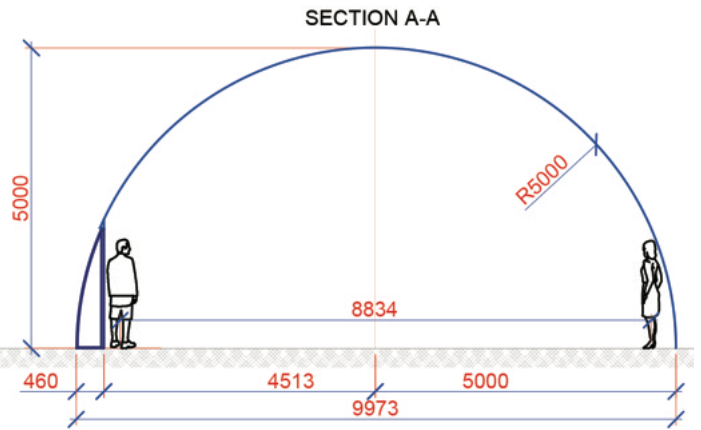
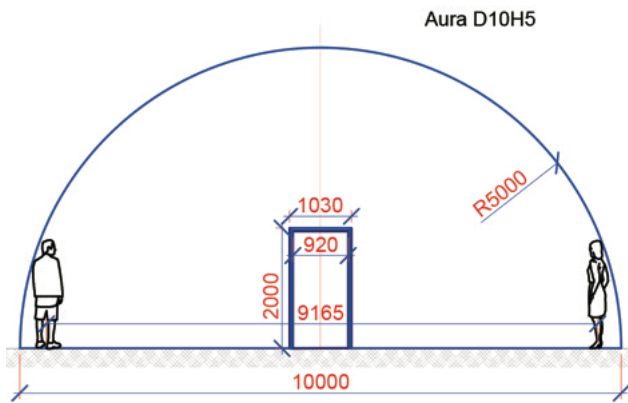

A

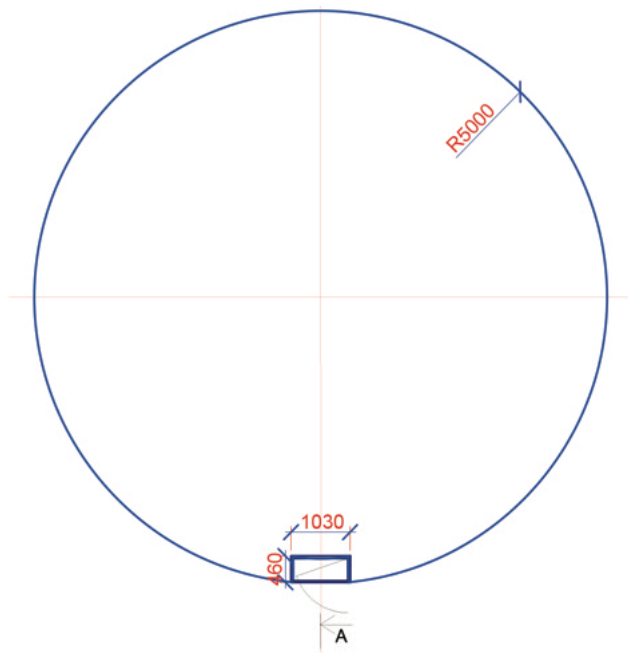

Structure



- 球面面積 ——— 157m²
- 床面積 ——— 78m²
- 内容積 ——— 262m³
- 重量 ——— 1300kg

Aura Dome 直径11m 高さ5.5m

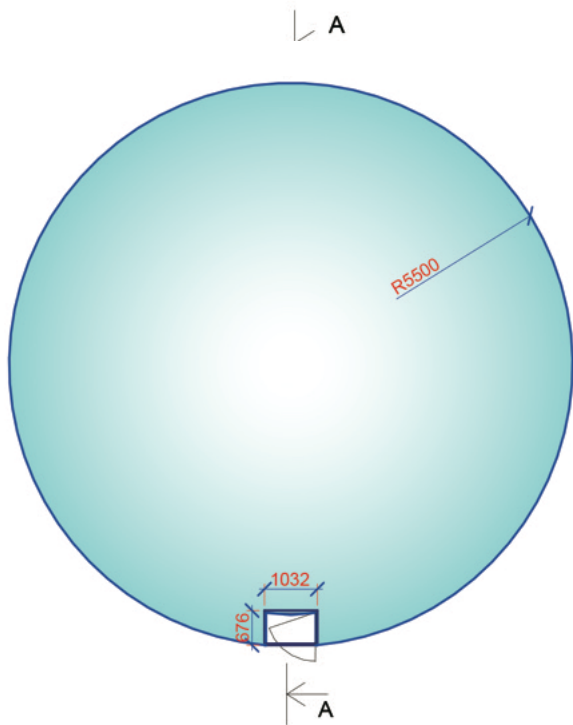
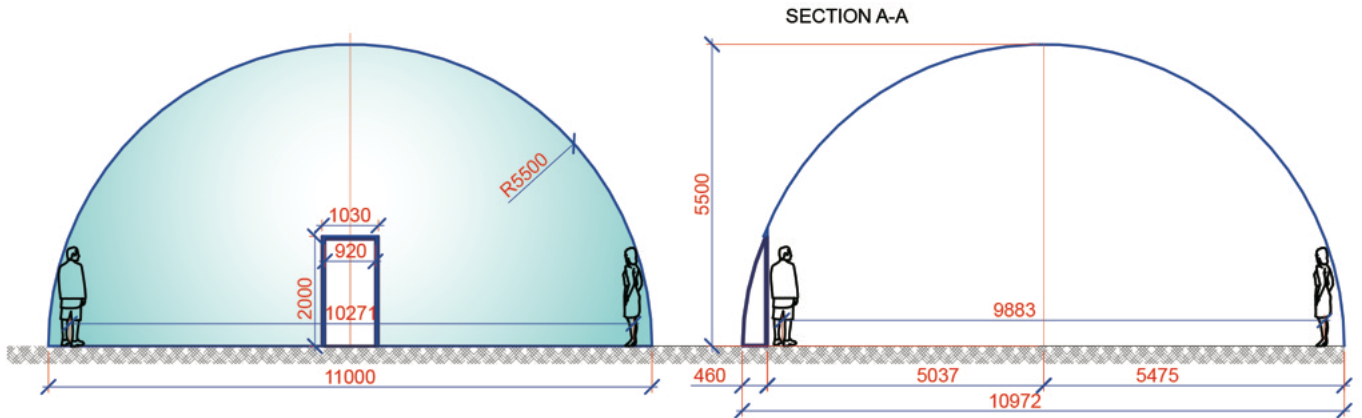

Structure



球面面積	——	190m ²
床面積	——	95m ²
内容積	——	348.26m ³
重量	——	1555kg

Aura Dome 直径12m 高さ6m

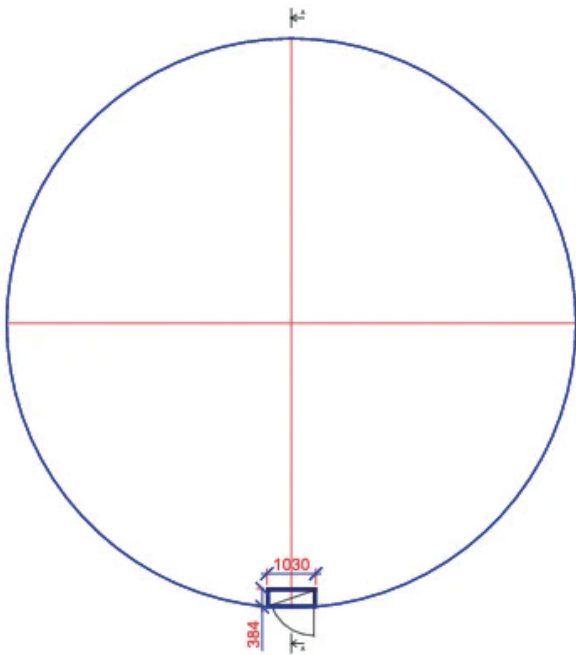
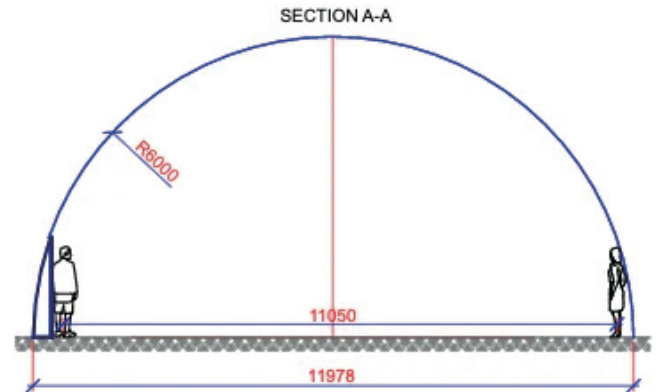
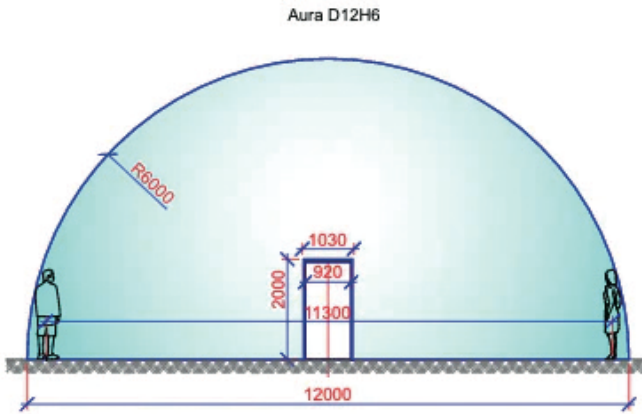

Structure



- 球面面積 ——— 226m^2
- 床面積 ——— 113m^2
- 内容積 ——— 452m^3
- 重量 ——— 2000kg

1/2 Aura Shelter 直径 4.5m 高さ 2.67m

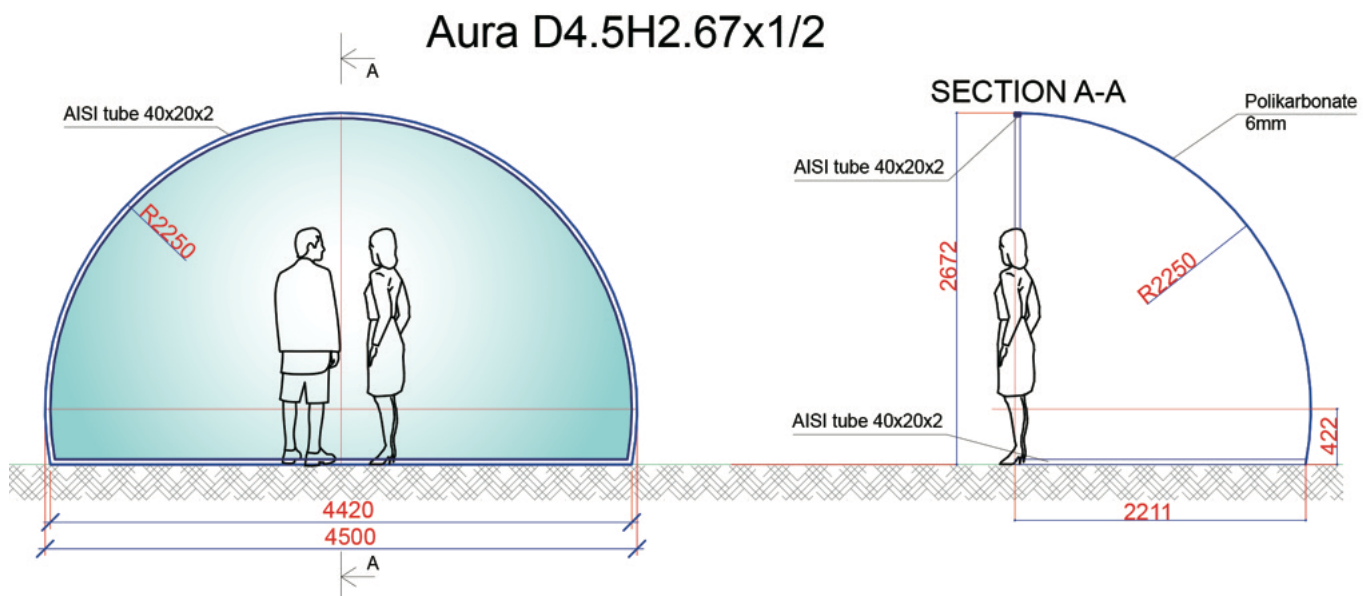

Structure

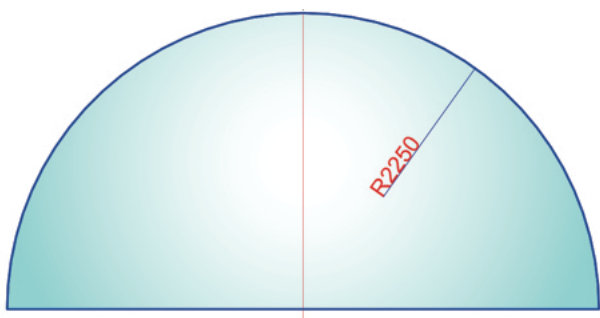

球面面積 —— 19m²

重量 —— 480kg

½ Aura Shelter 直径5m 高さ2.5m

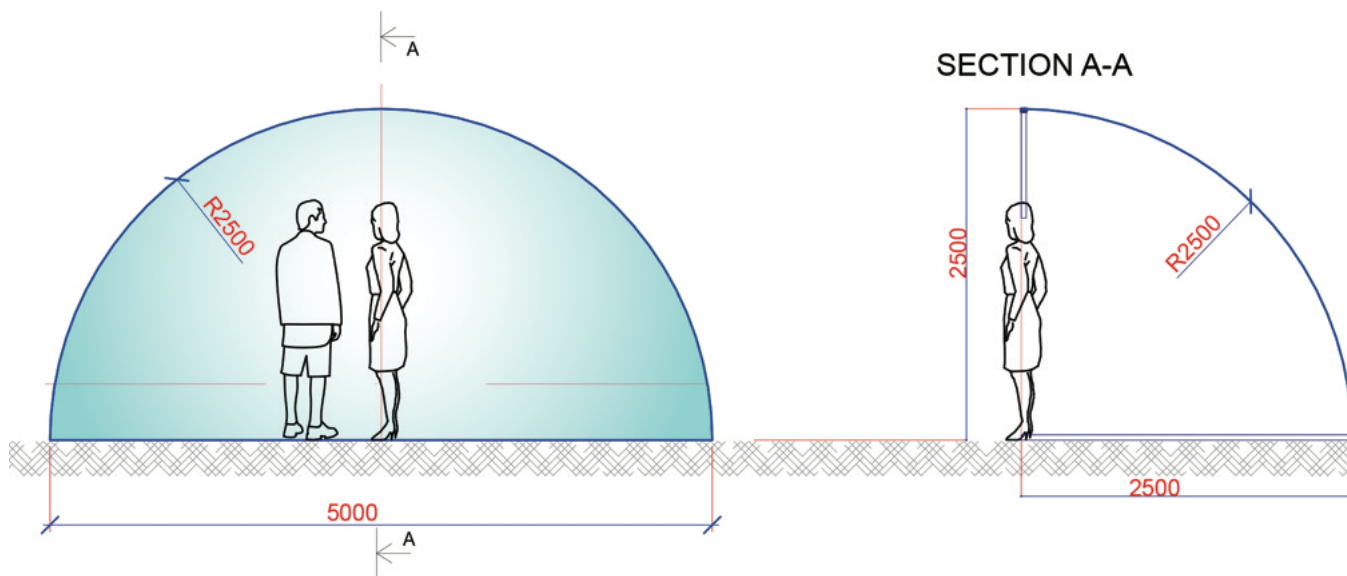

Structure

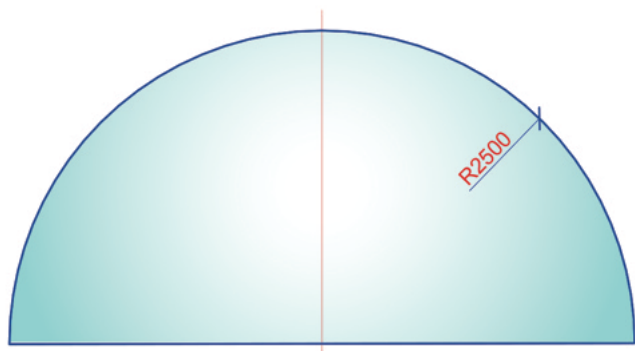

球面面積 ——— 19.65㎡

床面積 ——— 9.8㎡

重量 ——— 93kg

½ Aura Shelter 直径6m 高さ3m

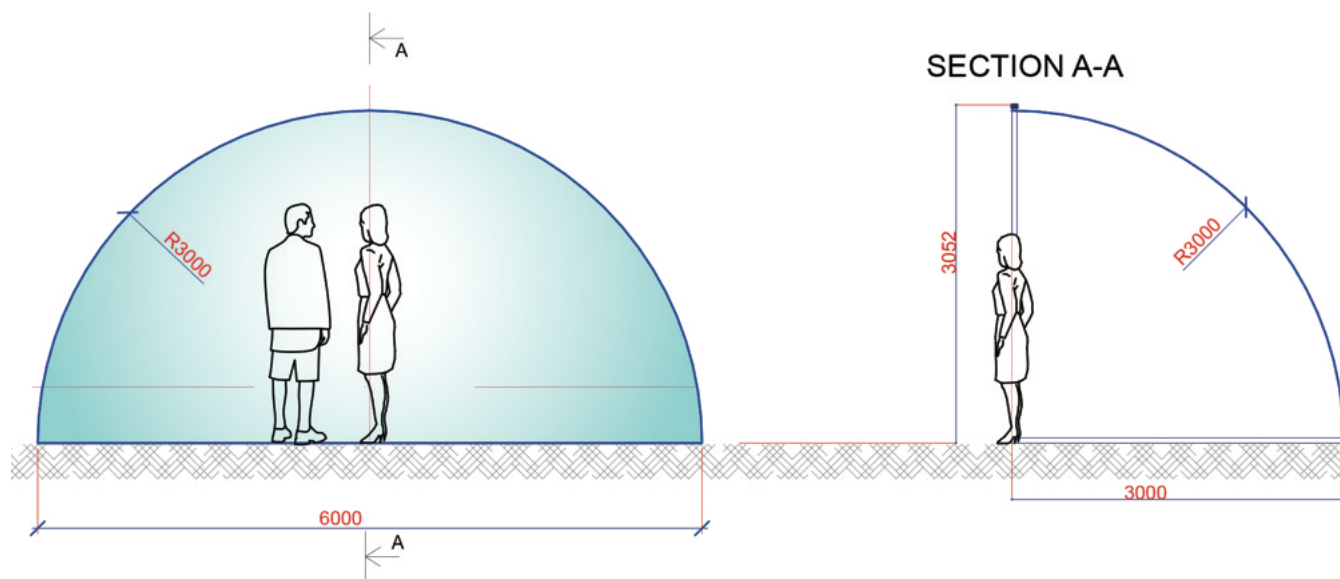

Structure

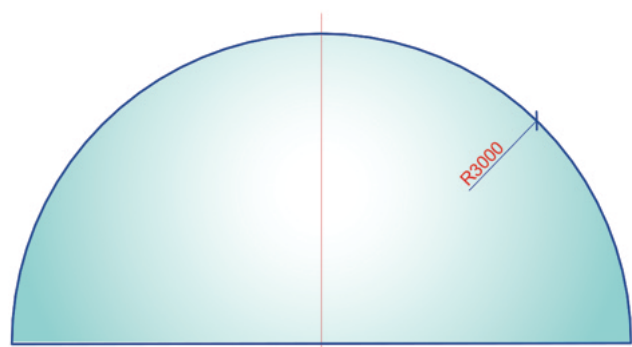

- 球面面積 ——— 28.25㎡
- 床面積 ——— 14.15㎡
- 重量 ——— 134.5kg

½ Aura Shelter 直径7m 高さ3.5m

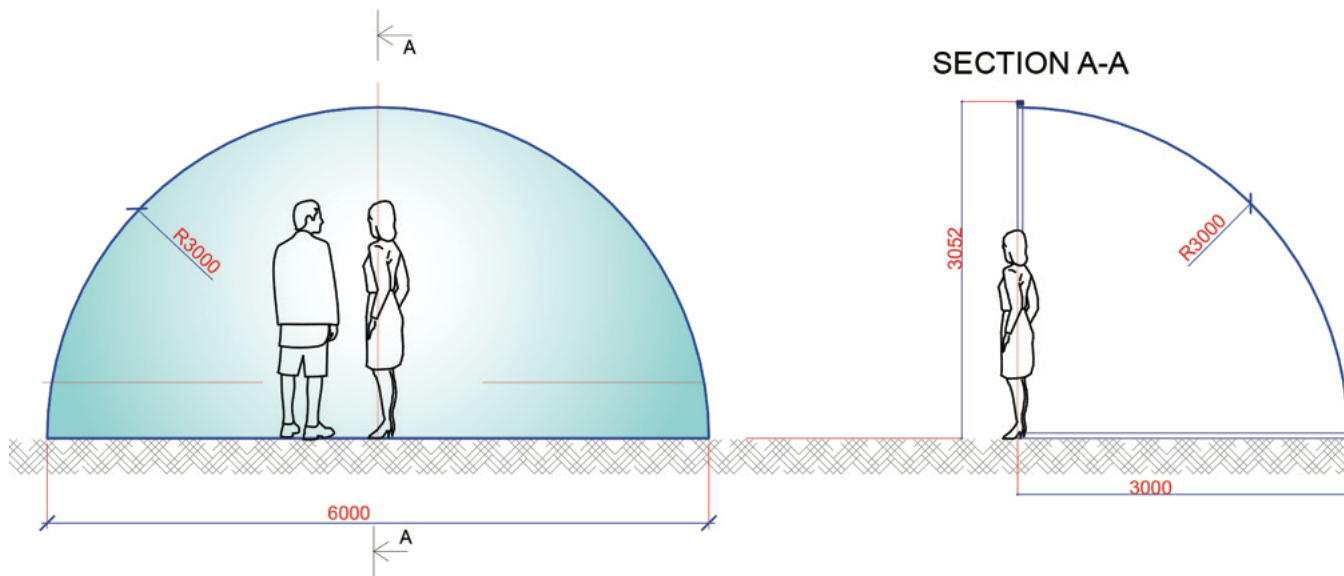

Structure

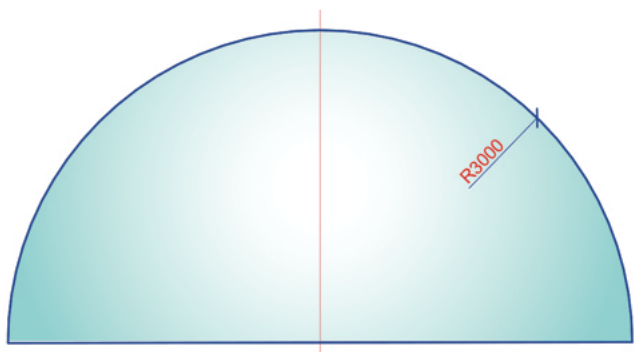

球面面積 —— 32.95㎡

床面積 —— 18.85㎡

重量 —— 183kg

½ Aura Shelter 直径8m 高さ4m

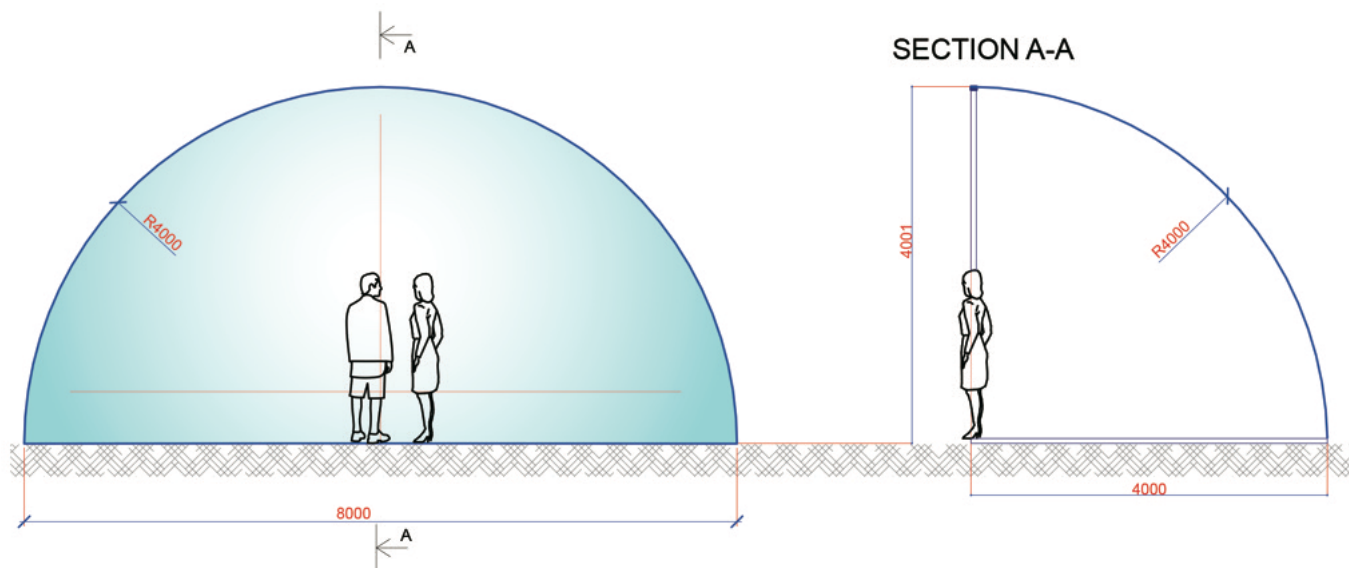

Structure

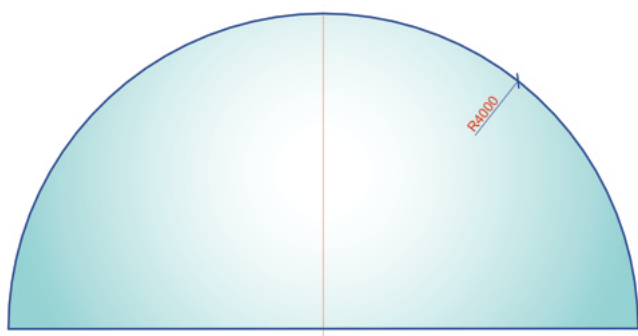

球面面積 ——— 50㎡
床面積 ——— 25㎡
重量 ——— 318kg

½ Aura Shelter 直径9m 高さ4.5m

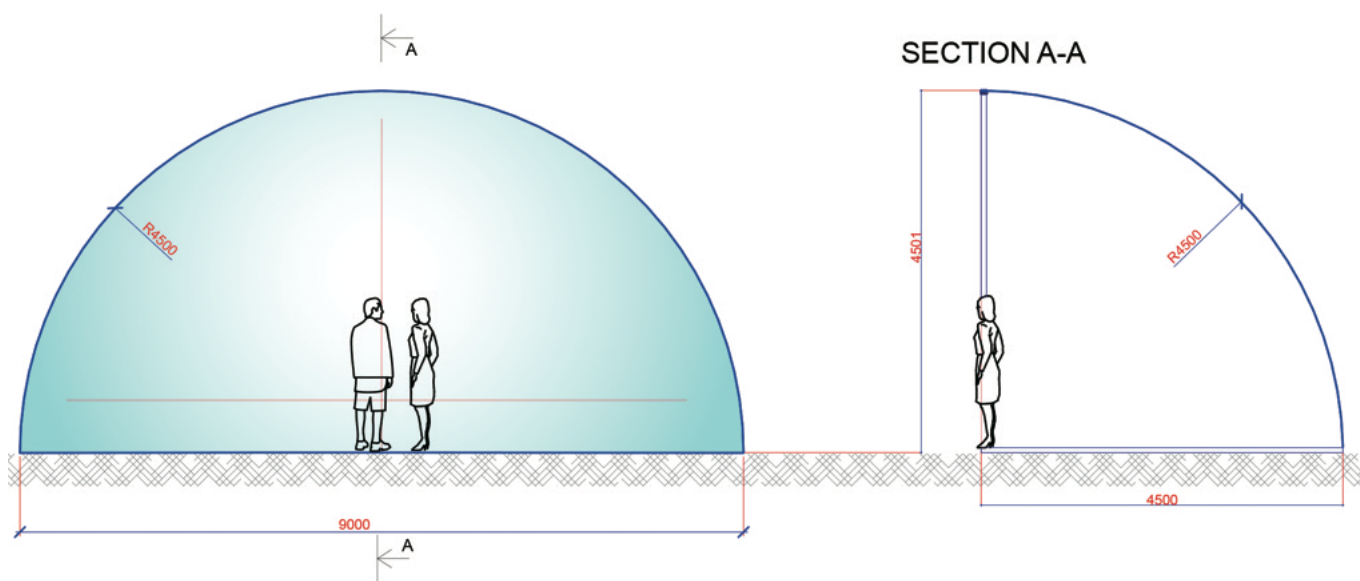

Structure

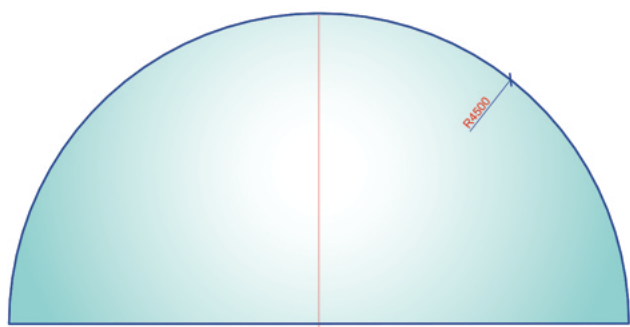

球面面積 —— 63.6㎡

床面積 —— 31.8㎡

重量 —— 403kg

½ Aura Shelter 直径10m 高さ5m

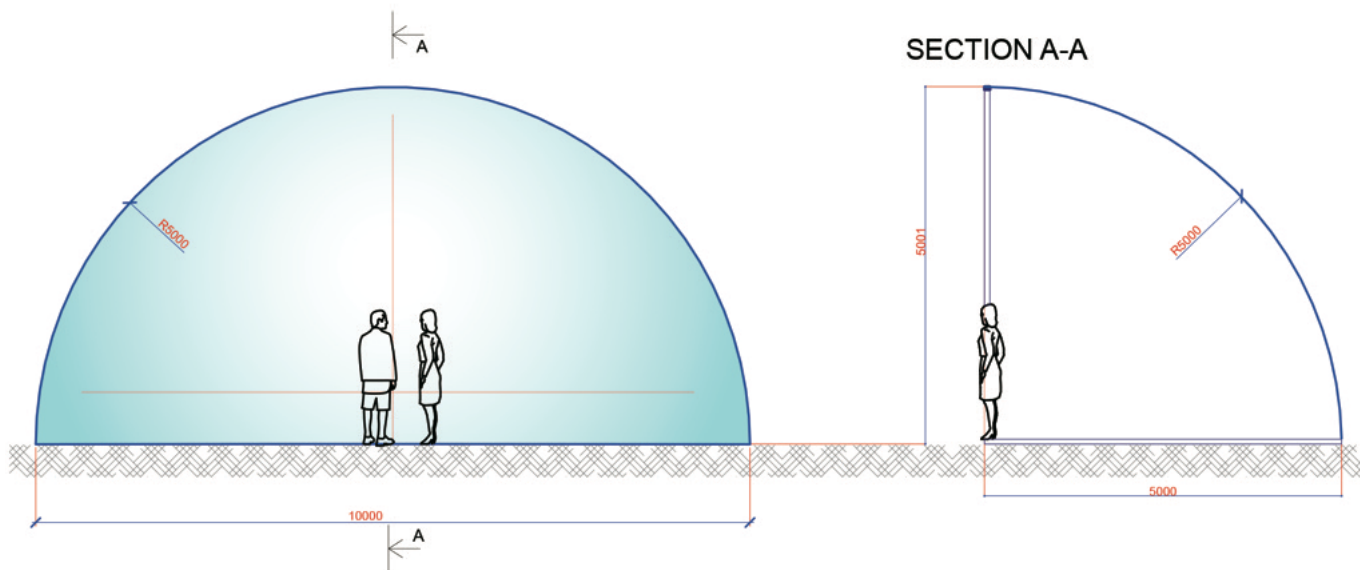

Structure

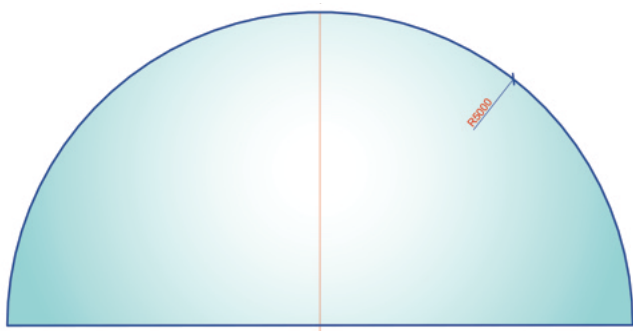

球面面積 —— 78.5㎡

床面積 —— 39.25㎡

重量 —— 746kg

2/3 Aura Shelter 直径5m 高さ2.5m

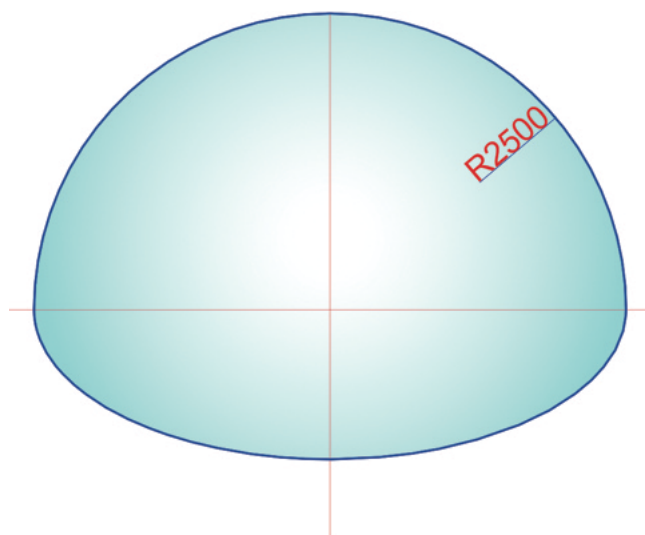
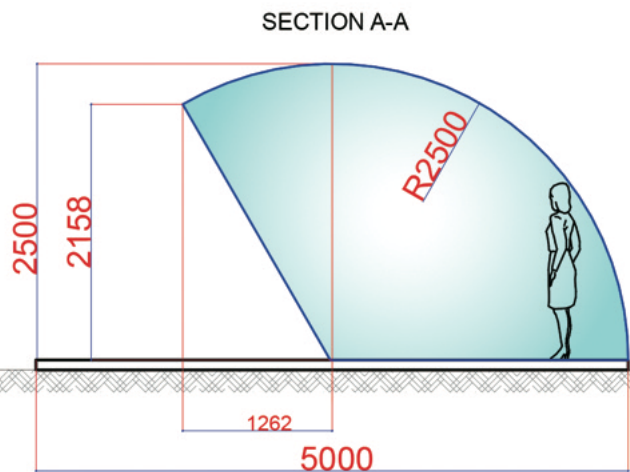
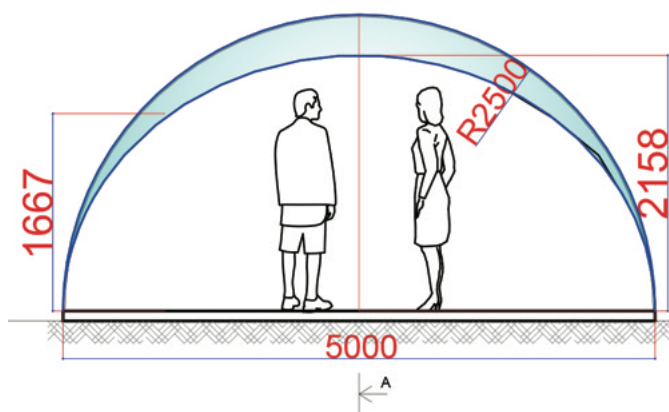

Structure



球面面積 —— 26.2㎡

重量 —— 124kg

2/3 Aura Shelter 直径6m 高さ3m

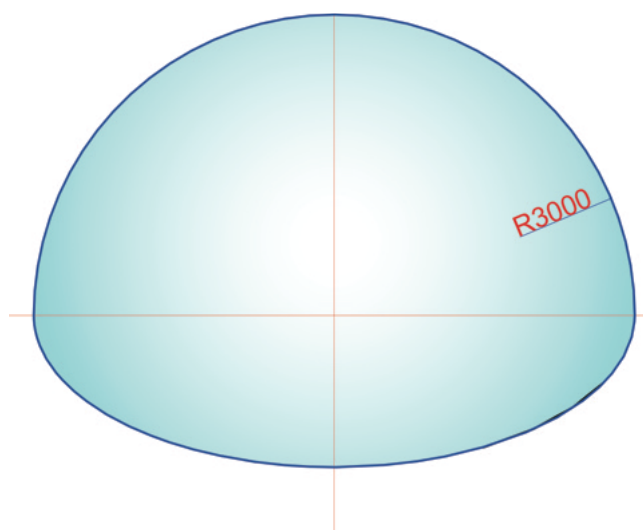
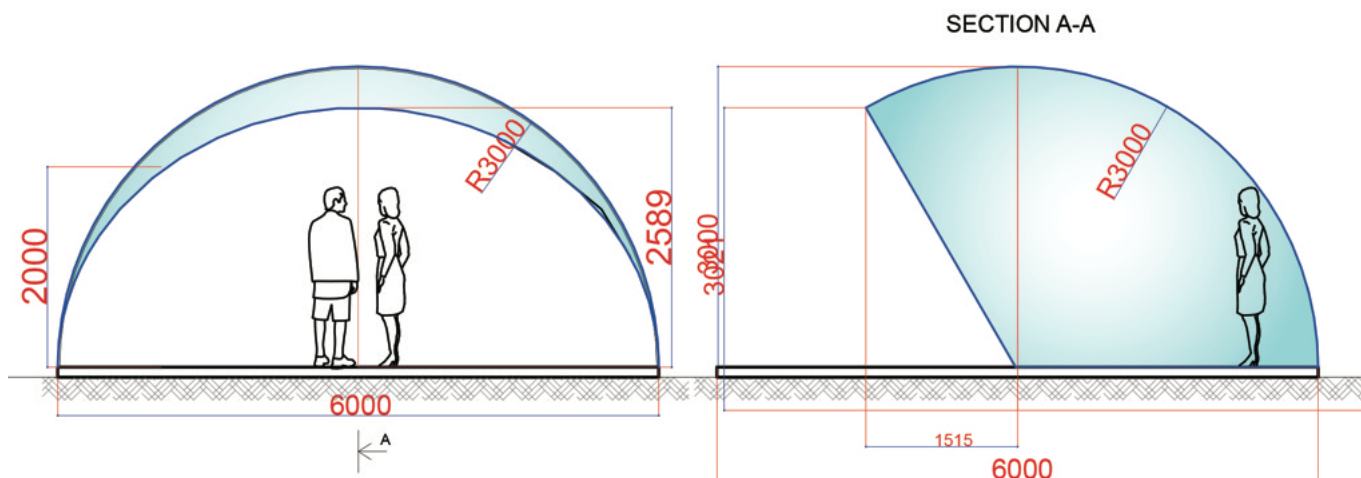

Structure



球面面積 —— 31.4㎡

重量 —— 149.3kg

2/3 Aura Shelter 直径7m 高さ3.5m

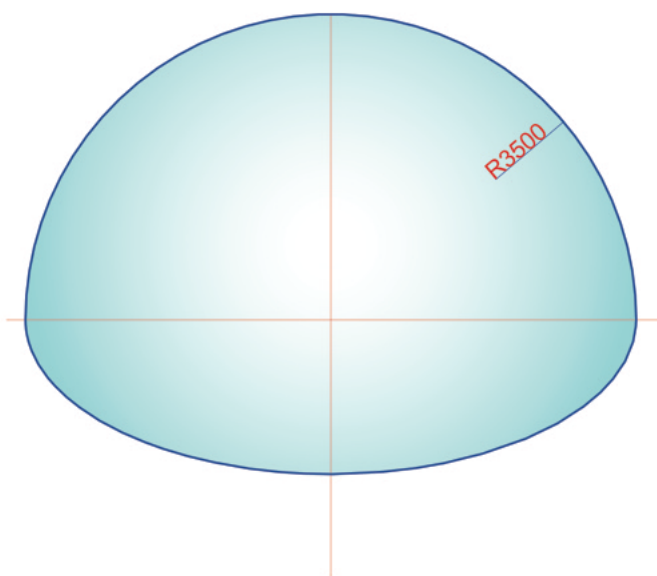
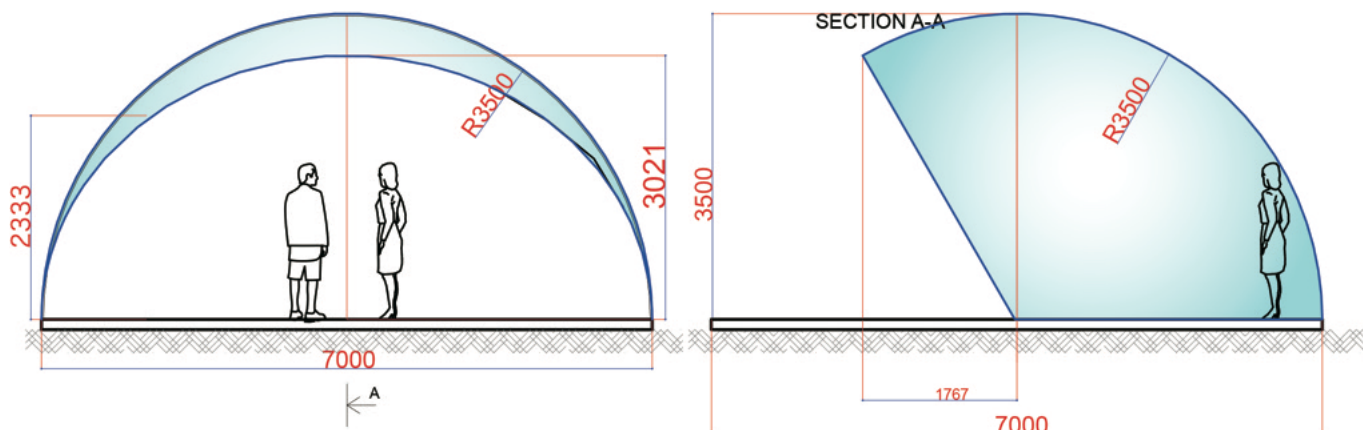

Structure



球面面積 —— 51.2㎡

重量 —— 244kg

2/3 Aura Shelter 直径8m 高さ4m

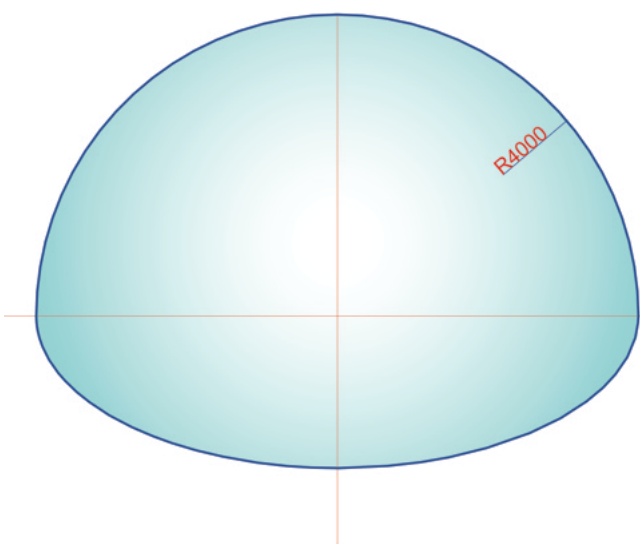
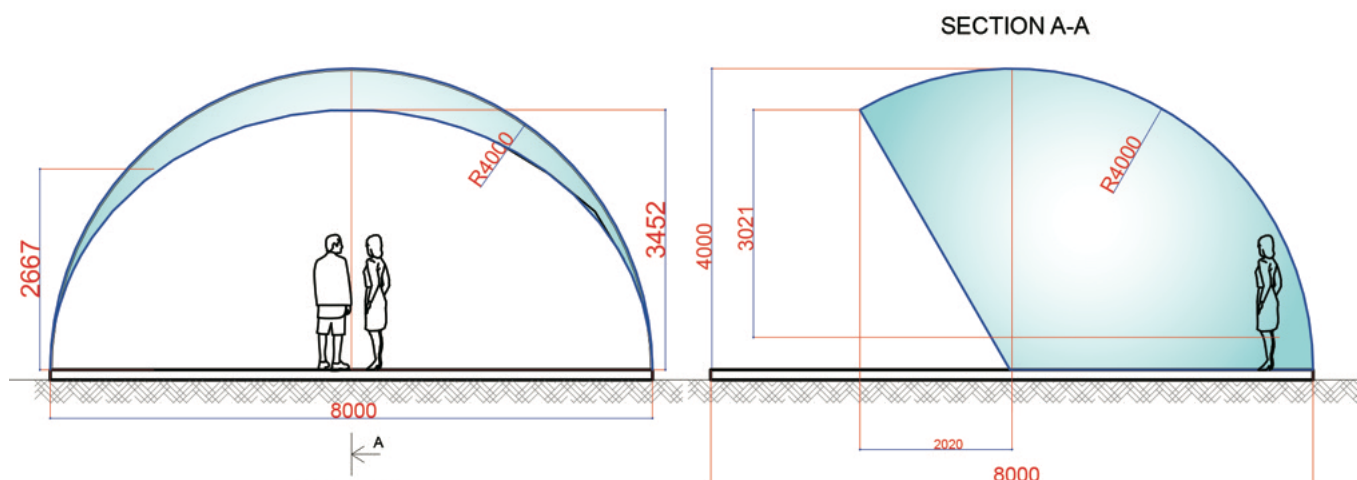

Structure



球面面積 ——— 67m²

重量 ——— 424.6kg

2/3 Aura Shelter 直径9m 高さ4.5m

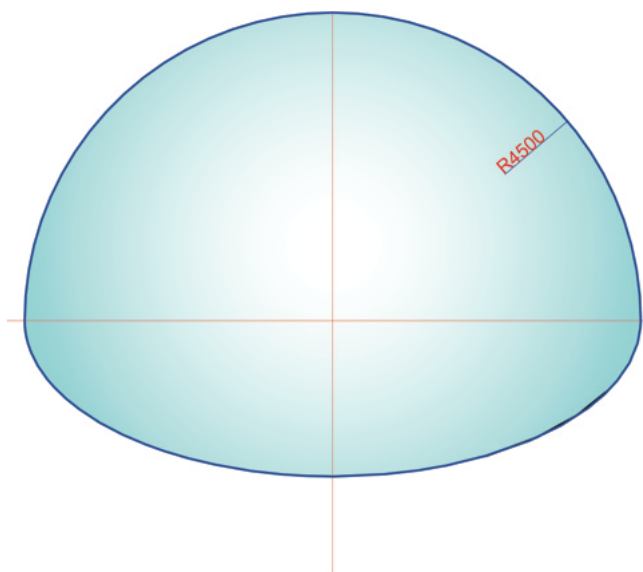
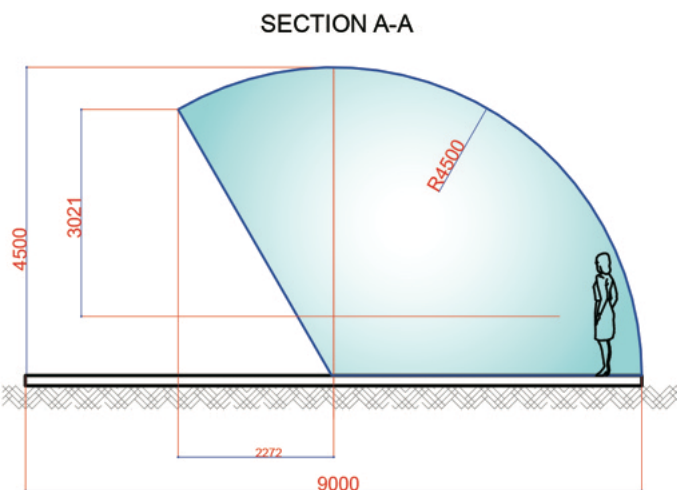
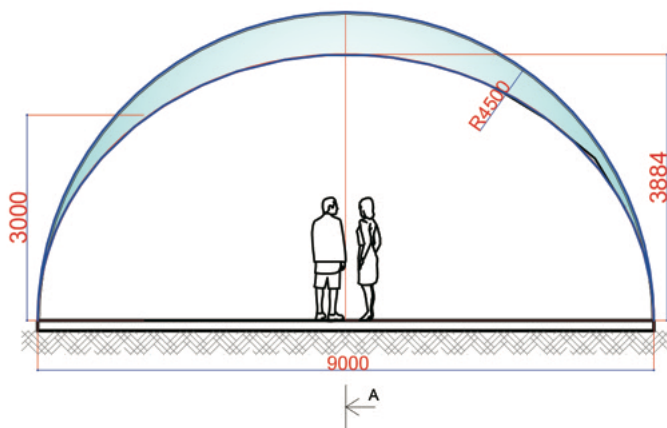

Structure



球面面積 ——— 75㎡

重量 ——— 477kg

2/3 Aura Shelter 直径10m 高さ5m

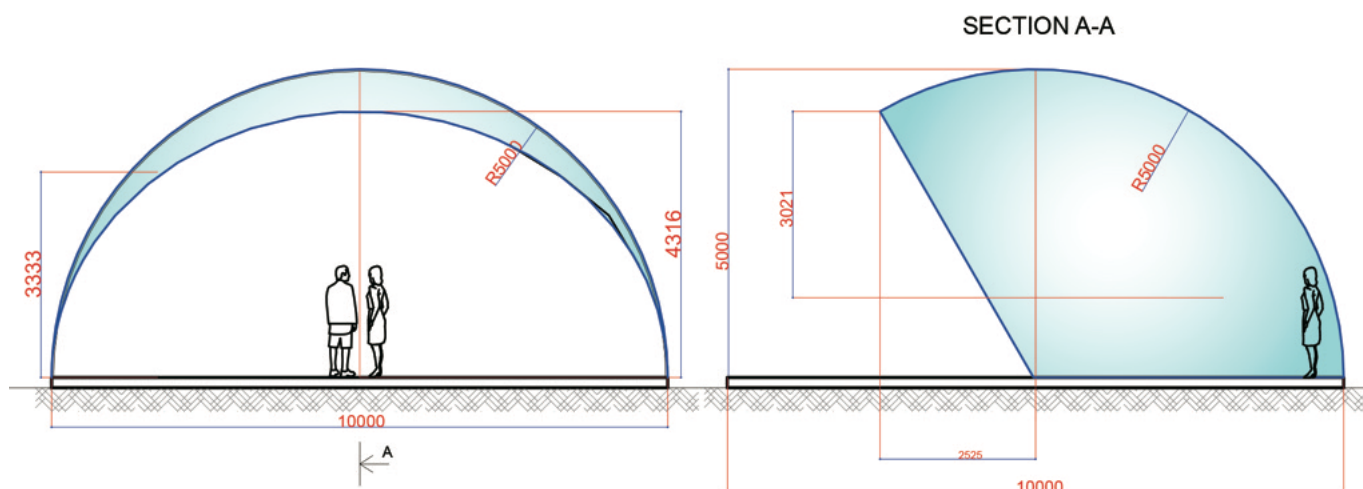

Structure

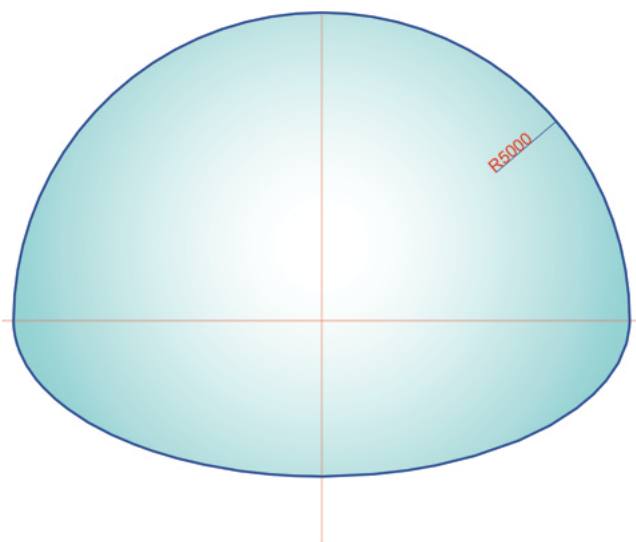

球面面積 ——— 104 m²

重量 ——— 994kg

Aura Glamping 直径6m 高さ3m

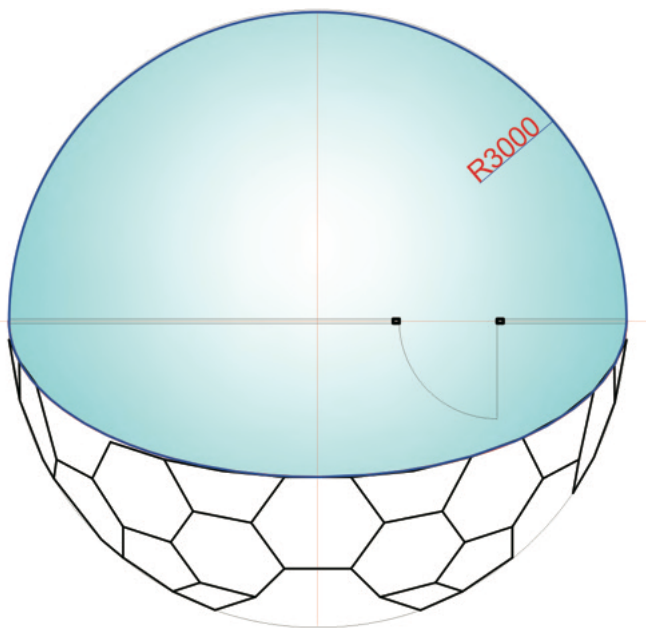
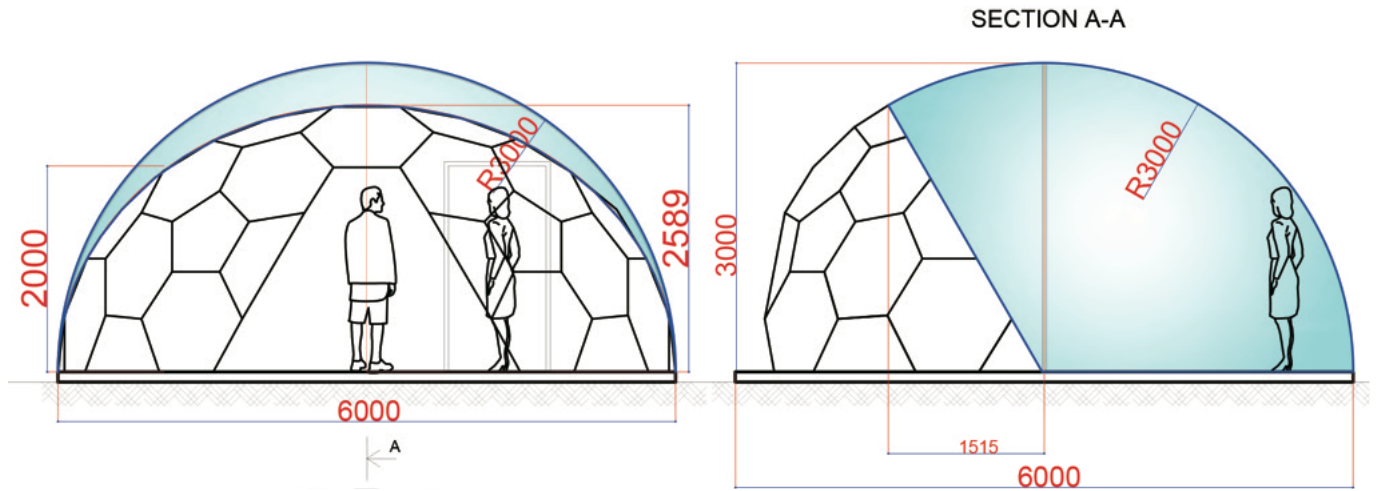

Structure

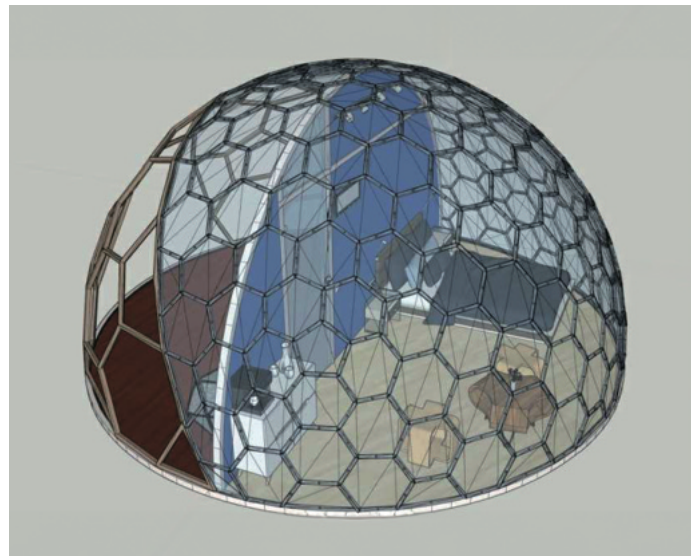

球面面積	37㎡
床面積 (室内)	14㎡
テラス面積 (屋外)	14㎡
内容積	28㎡

Aura Glamping 直径7m 高さ3.5m

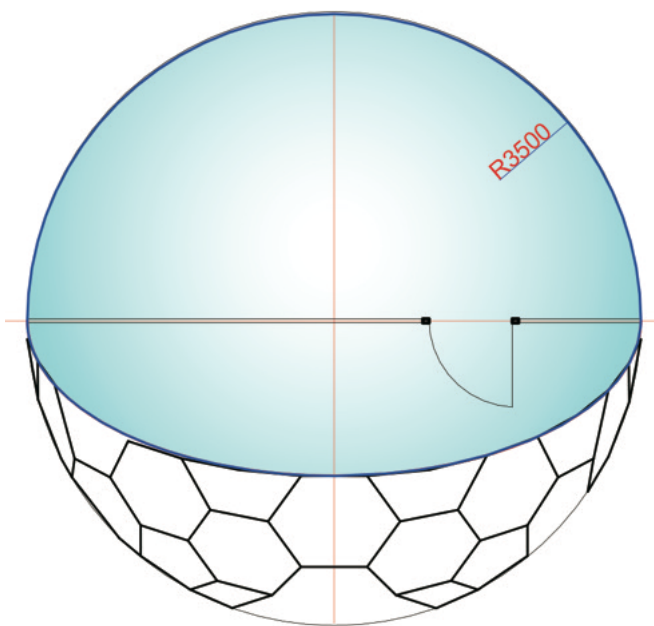
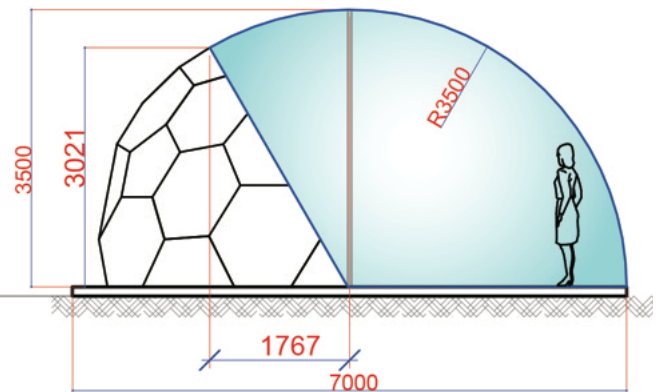
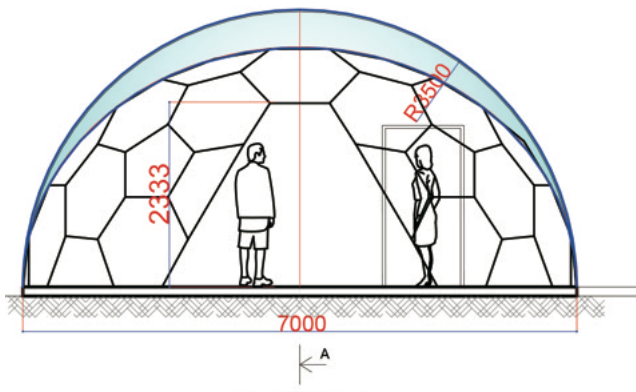

Structure

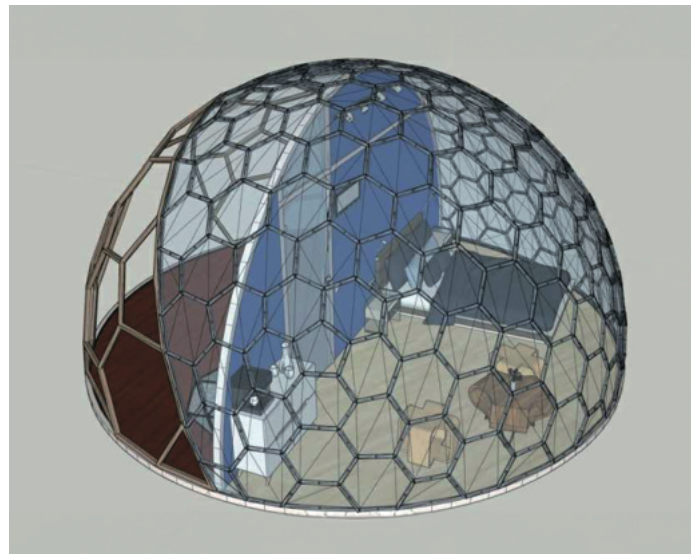

球面面積 ————— 51m²

床面積 (室内) ————— 19m²

テラス面積 (屋外) ————— 19m²

内容積 ————— 45m³

Aura Glamping 直径8m 高さ4m

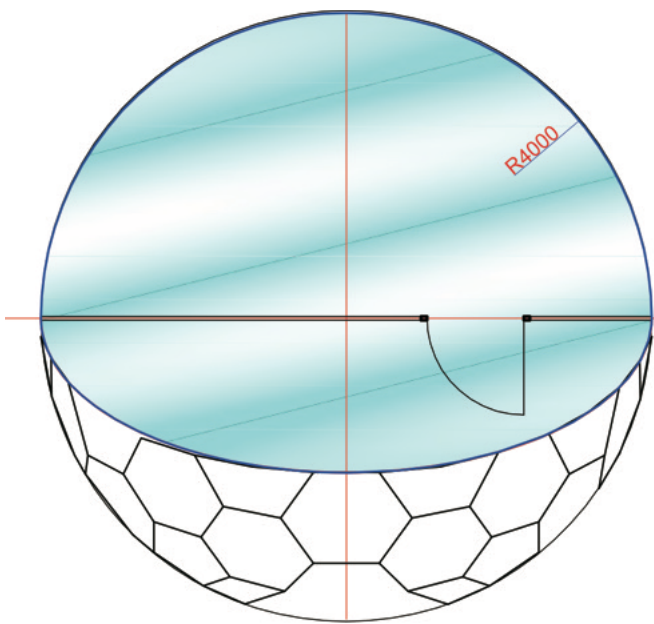
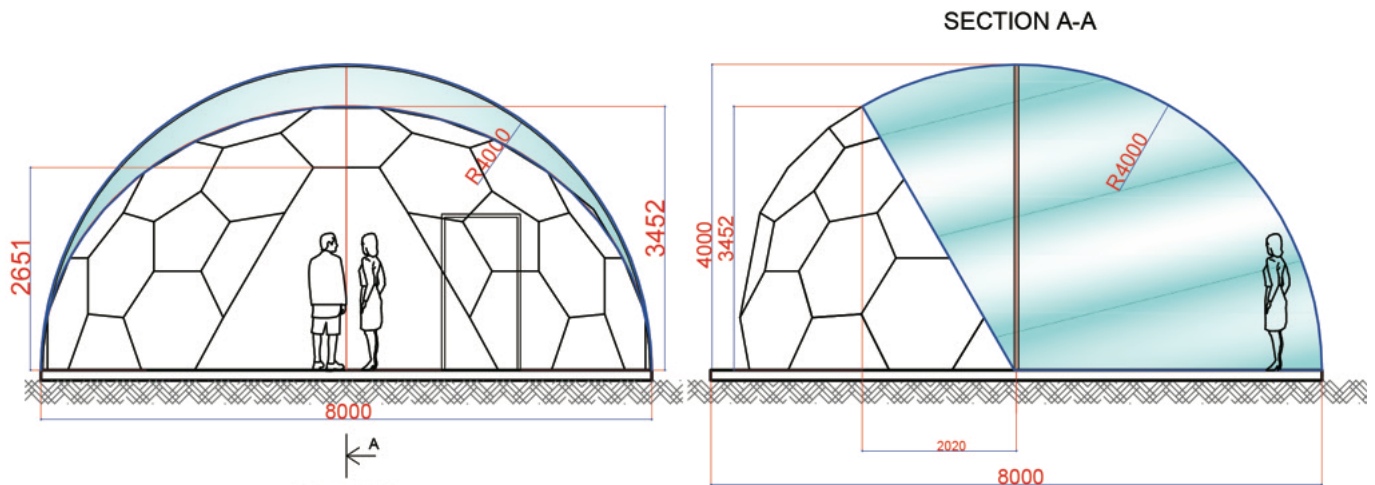

Structure

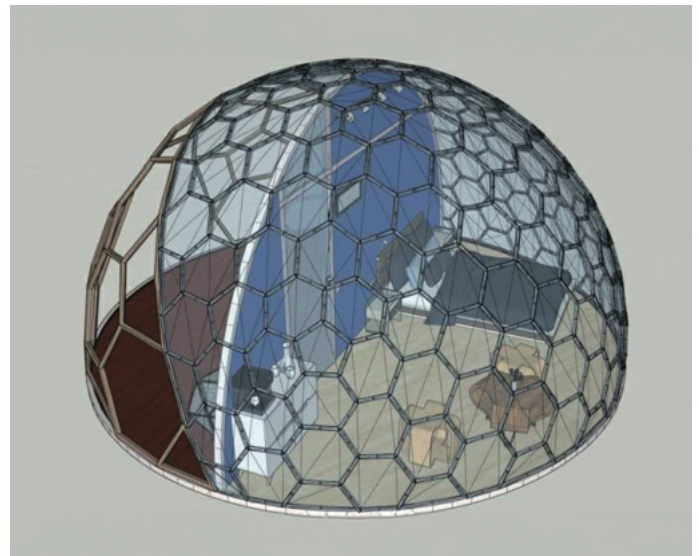

球面面積	—————	66.6㎡
床面積(室内)	—————	25㎡
テラス面積(屋外)	—————	25㎡
内容積	—————	66.5㎡

Aura Glamping 直径9m 高さ4.5m

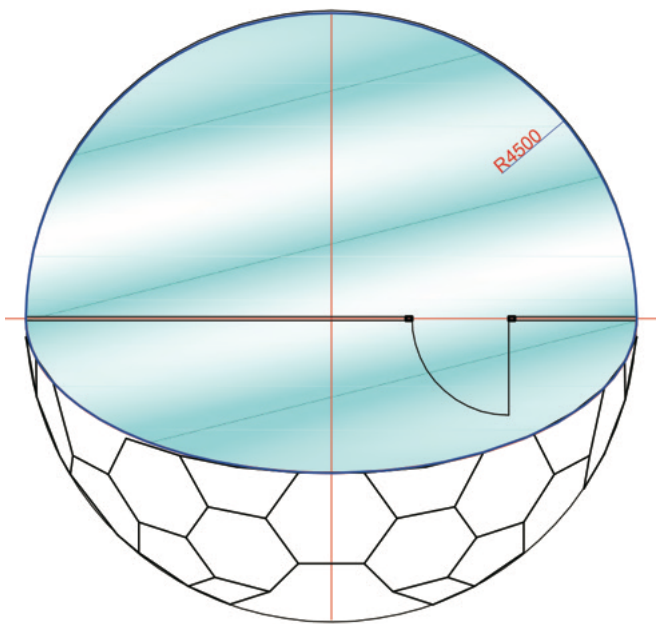
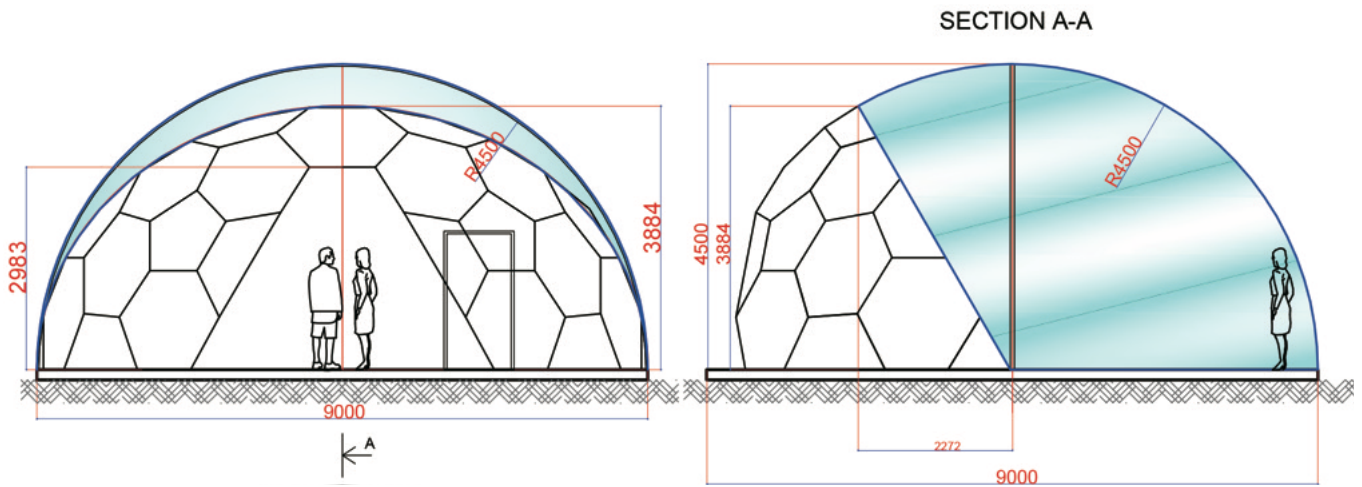

Structure

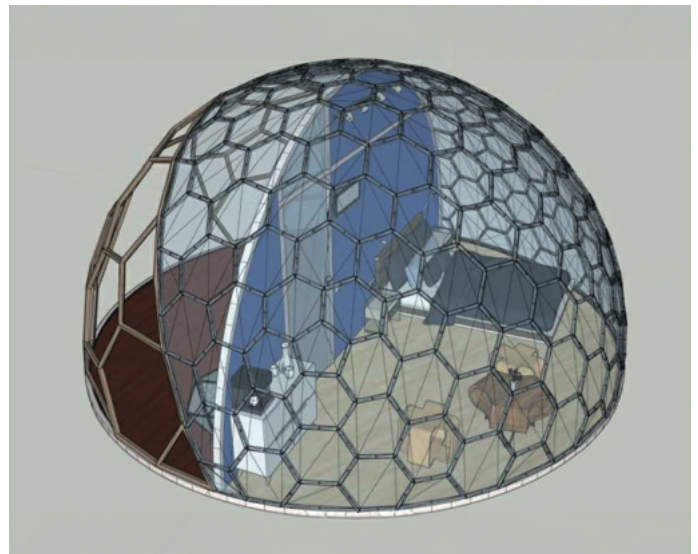

球面面積	—————	75㎡
床面積(室内)	—————	31.4㎡
テラス面積(屋外)	—————	31.4㎡
内容積	—————	84.7㎡

Aura Glamping 直径10m 高さ5m

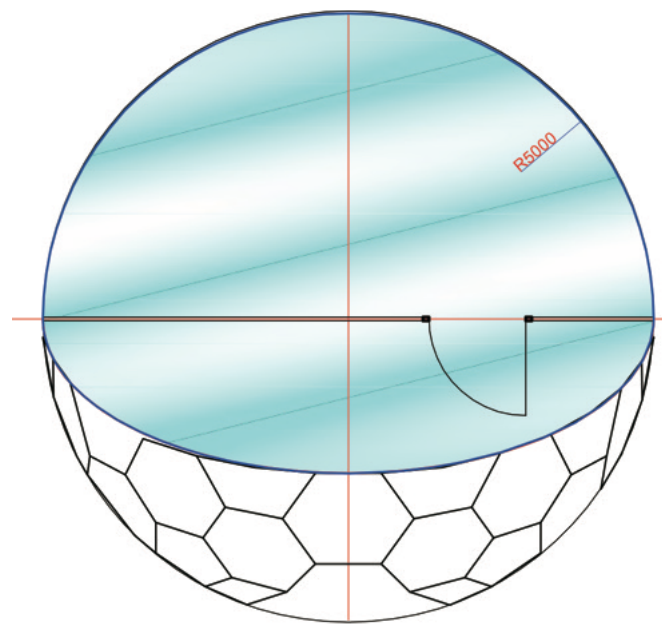
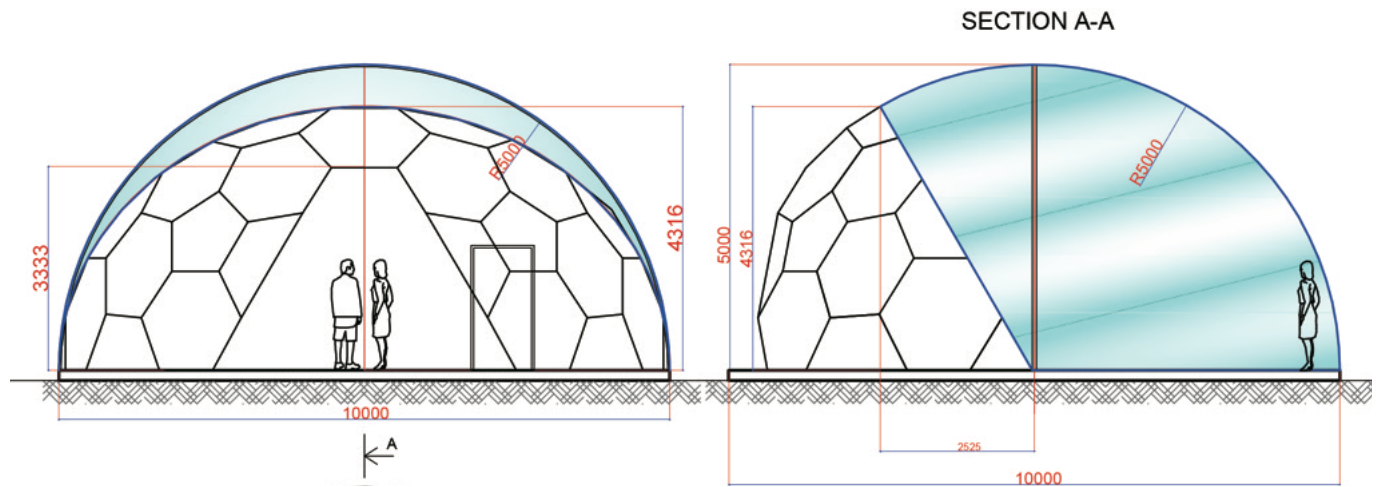

Structure

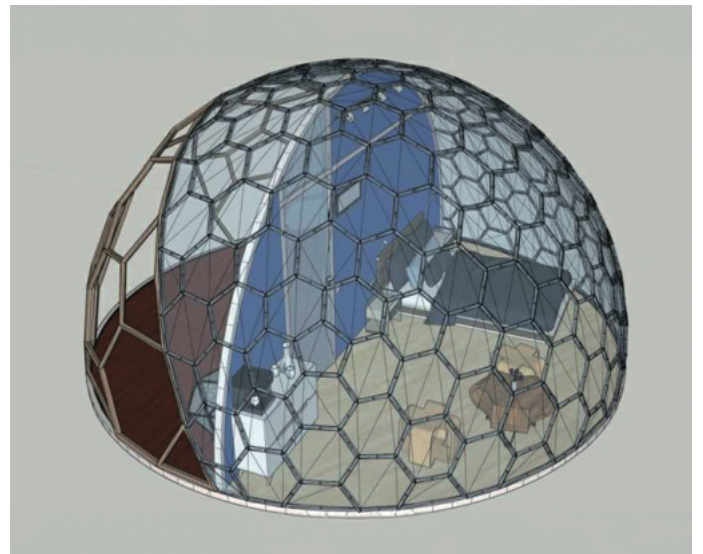

球面面積	104㎡
床面積(室内)	39.25㎡
テラス面積(屋外)	39.25㎡
内容積	130.5㎡

Aura Tunnel 長さ24m 幅12m

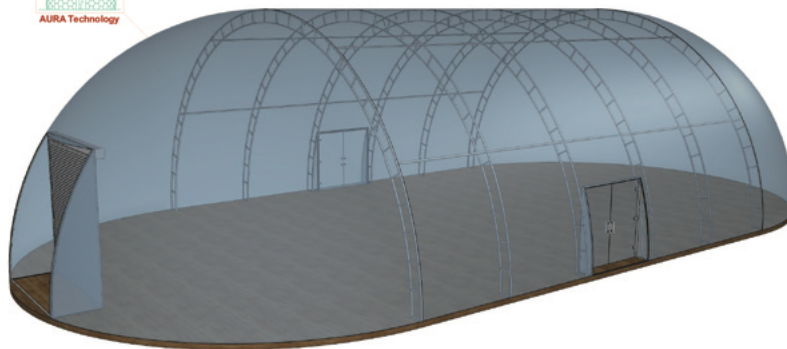
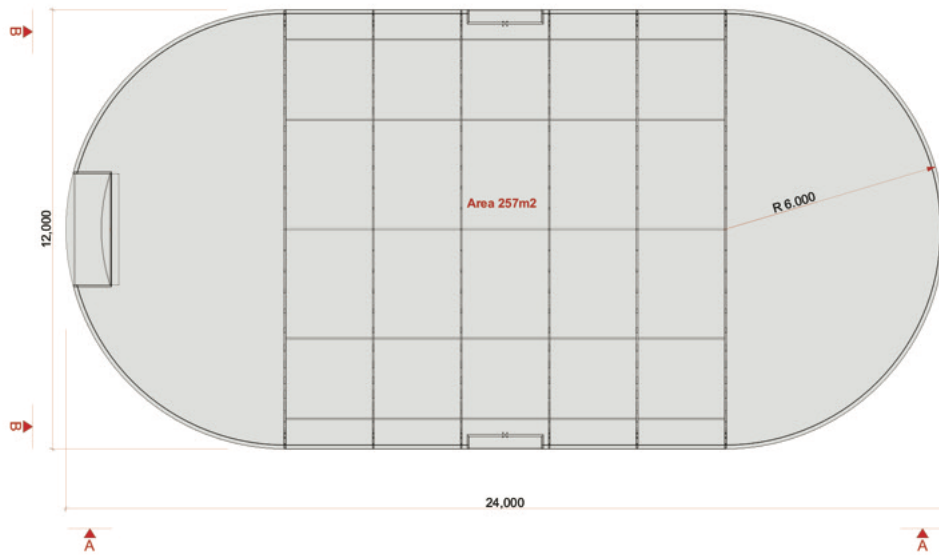
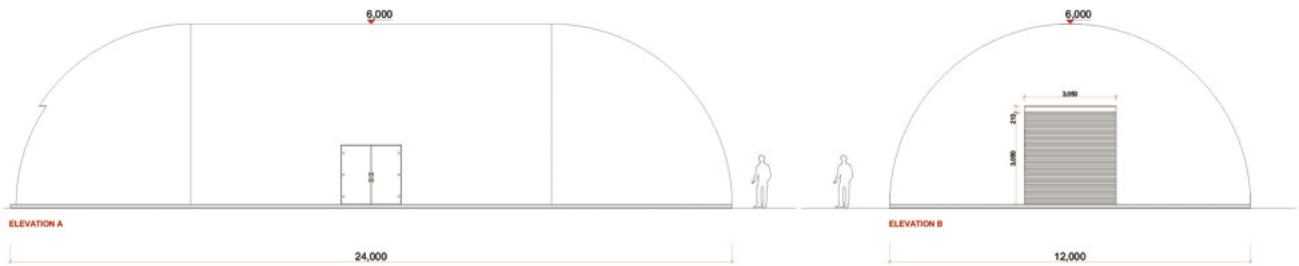

Aura Tunnel 長さ4.87m 幅2.44m

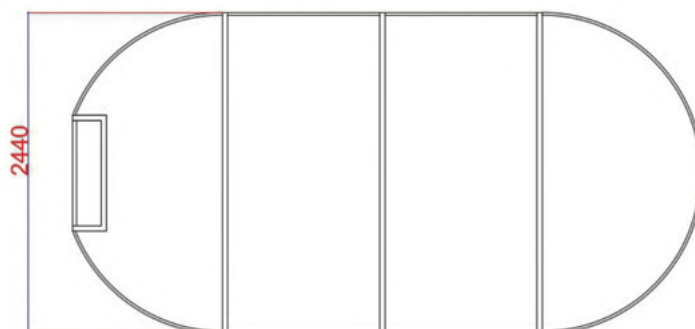
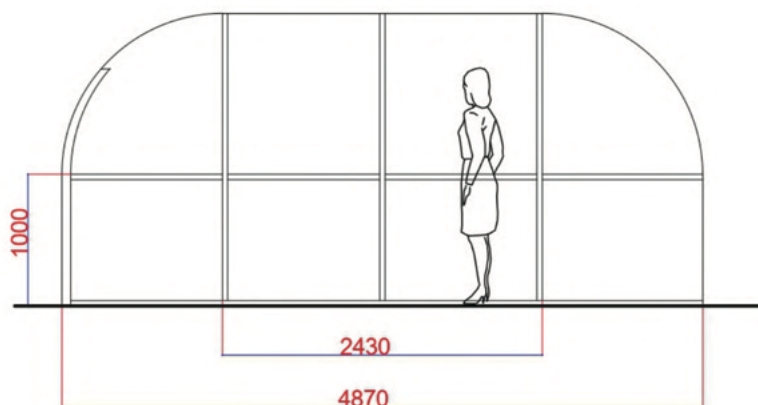
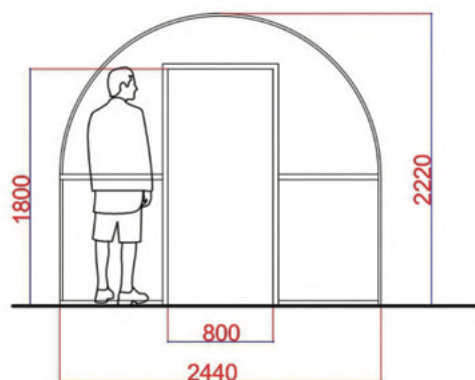

球面面積 ————— 30.4㎡

床面積 ————— 10.5㎡

内容積 ————— 20㎡

PVCドア ————— 1pc

Aura Tunnel 長さ13m 幅5m

Aura D5H3

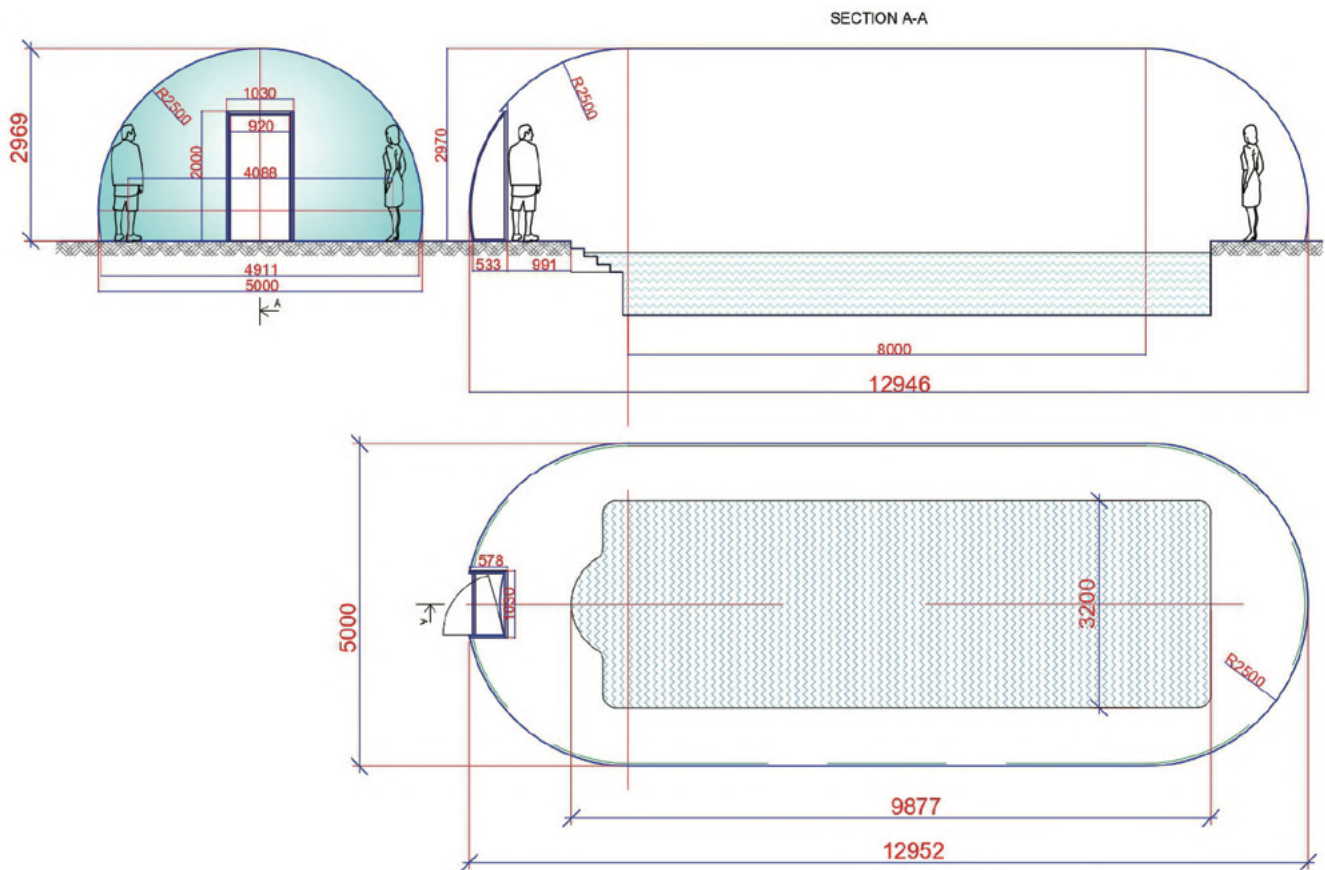

カバー表面面積 ——— 117㎡

床面積 ——— 59㎡

内容積 ——— 140㎡

重量 ——— 750kg



**VIKING
DOME
JAPAN**

Viking Dome Japan

エンジニアリングおよび建設会社
アウラドーム技術の開発・製造

お問合せはこちら



vikingdome.jp/contact/

夢木香株式会社 ドーム事業部

TEL. 052-848-8444

